

Direct Sourcing Solutions Ltd



DAF Replacement Parts



5.14.1

www.direct-sourcing-solutions.com
E mail: sales@direct-sourcing-solutions.com



1: Engine	1
2: Cooling	2
3: Fuel	3
4: Exhaust - To Follow	4
5: Engine Control	5
6: Clutch	6
7: Gearbox	7
8: Propshaft	8
9: Rear Axle	9
10: Front Axle	10
11: Wheels & Hubs	11
12: Suspension	12
13: Steering	13
14: Brakes	14
15: Cab & Body	15
16: Electrical	16

Suffix Key; OE = Original Equipment, R = Reconditioned Part
OEM = Original Equipment Manufacturer, ALT = Alternative Supplier Part

OE Numbers used for Cross Reference Purposes Only

sales@direct-sourcing-solutions.com www.direct-sourcing-solutions.com

Tel; +44 (0) 1653 668179 Fax; +44 (0) 1905 507755

General Information

This Catalogue contains Aftermarket Spare Parts suitable for DAF vehicles.

The first line contains the DSS Part Number, the second line shows the OE numbers and the third line **[in bold]** gives a brief description.

The following two lines relate to Vehicle Application, Individual Model Fitment, and also to assist in identification of the Engine, Gearbox or Rear Axle type.

The final line offers additional information to help with identification, with further qualification where possible using Engine or Chassis number.

Whilst every effort has been made to ensure all information in this catalogue is correct, we cannot accept any responsibility whatsoever for any errors found in this publication.

To further assist in identifying individual parts, why not check out the DSS website, www.direct-sourcing-solutions.com

Vehicle Types Description

The VIN (Vehicle Identification Number) consists of the following series of numbers and letters: Example VIN Nr. XLRAE65NC0E474701

X	= Netherlands
L	= /
R	= DAF
A	= Vehicle design
E	= Axle combination
65	= Series
N	= Engine family
C	= Engine type
0E474701	= Chassis number

Vehicle designs:

A	= Transportation of cargo
B	= Bus
C	= Bus
D	= Bus
F	= Fire brigade vehicle
G	= Refuse collection vehicle
K	= Tipper
M	= Mixer vehicle
R	= Tank vehicle
T	= Tractor-trailer rig

Vehicle type: FA 65CF

FA	= Axle combination
65CF	= Series

Axle Combinations

E	= 4x2
R	= 6x2 Trailing axle with single wheels
S	= 6x2 Trailing axle with twin wheels
T	= 6x4
V	= 4x4
Z	= 6x6
B	= 6x2 Two front axles
C	= 8x2
D	= 8x4
G	= 6x2 Steered pusher axles

Engine Types Description

Engine family:

B	= 2,50 litre
C	= 5,85 litre
N	= 6,20 litre
H	= 8,25 litre
K	= 11,60 litre
L	= 11,60 litre (horizontal engine)
W	= 11,60 litre (cross-flow)

Engine type:

A	= Coordinated intake svstem
B	= Turbo, throttled
C	= Turbo
D	= Suction engine, throttled
N	= Suction engine
S	= Turbo + Intercooling
T	= Turbo
X	= Special model

Year of Construction

F 800/1000/1100, F 1300/1600/1700, F 1800/1900/2100, F 2300/2500/2700, F 2800/2900/3200, F 3300/3600	= 1973 – 1991
F45	= 1996 – 2001
F 55	= 1995 – 2001
F65/75/85	= 1992 – 1998
F 95	= 1987 – 1997
65/75/85 CF	= 1998 – 2001
95 XF	= 1997 – 2002
LF 45/55	= 2001 – 2006
LF 45/55/II/III/IV	= 2006 –
CF 65/75/85	= 2001 – 2006
CF 65/75/85/II/III/IV	= 2006 –
XF 95	= 2002 – 2006
XF 105	= 2005 –

DSS Ltd do not have, or wish to imply any connection whatsoever with any DAF Truck Dealers / Manufacturers and / or their branding. Any part numbers are exclusively for reference purposes and do not indicate or imply any connection between DSS Ltd and any manufacturer and / or their parts / systems whatsoever. All data / contents contained within this publication copyright DSS Ltd 2014

E&OE

Direct Sourcing Solutions

DAF Catalogue 5.14.1

1: Engine Index



1

Cylinder Head Gaskets	Pg: 9
Cylinder Heads And Bolts	Pg: 11
Engine Mountings	Pg: 16
Exhaust Manifold Gaskets	Pg: 12
Filters, Air	Pg: 1-2
Filters, Fuel	Pg: 5-6
Filters, Miscellaneous	Pg: 7
Filters, Oil	Pg: 3-4
Flywheel Ring Gear	Pg: 14
Flywheels And Bearings	Pg: 13
Oil Coolers, Gaskets And Associated Parts	Pg: 15
Rocker Cover Gaskets	Pg: 8
Sump Gaskets And Seals	Pg: 10

Suffix Key; OE = Original Equipment, R = Reconditioned Part
OEM = Original Equipment Manufacturer, ALT = Alternative Supplier Part

OE Numbers used for Cross Reference Purposes Only

sales@direct-sourcing-solutions.com www.direct-sourcing-solutions.com

Tel; +44 (0) 1653 668179 Fax; +44 (0) 1905 507755

Direct Sourcing Solutions

DAF Catalogue 5.14.1

Section 1: Engine



Filters, Air

501033

1317409

Air Filter

F65, F85, 85CF



501031

1664524

Air Filter

95XF, LF45, XF95



510009

1667999

Air Filter

LF45, LF55



510001

1679397

Air Filter

LF45, LF55



510008

1789292

Air Filter

CF75IV



1

Suffix Key; OE = Original Equipment, R = Reconditioned Part

OEM = Original Equipment Manufacturer, ALT = Alternative Supplier Part

OE Numbers used for Cross Reference Purposes Only

sales@direct-sourcing-solutions.com www.direct-sourcing-solutions.com

Tel; +44 (0) 1653 668179 Fax; +44 (0) 1905 507755

Section: 1, Pg: 1

Direct Sourcing Solutions

DAF Catalogue 5.14.1

Section 1: Engine



1

Filters, Air

510007

1789291 1726060 1638006

Air Filter

CF85



510011

1363024

Air Filter

85CF, CF85



510012

1664525

Air Filter

XF105



510003

1638054

Air Filter

XF105



510029

1854407

Air Filter

XF105

Flame Retardant Material



Suffix Key; OE = Original Equipment, R = Reconditioned Part
OEM = Original Equipment Manufacturer, ALT = Alternative Supplier Part

OE Numbers used for Cross Reference Purposes Only

sales@direct-sourcing-solutions.com www.direct-sourcing-solutions.com

Tel; +44 (0) 1653 668179 Fax; +44 (0) 1905 507755

Section: 1, Pg: 2

Direct Sourcing Solutions

DAF Catalogue 5.14.1

Section 1: Engine



Filters, Oil

510014

1376481

Oil Filter Canister

F75, 75CF, 85CF, 95XF, CF75, CF75IV, CF85, CF85IV, XF95



510015

1397765

Oil Filter, Paper Type

CF75, CF75IV, CF85, CF85IV, XF95



501010

1310901

Oil Filter

F95, 85CF, 95XF, XF95



510010

1399494

Oil Filter

65CF, LF45, LF55, CF65



501052

1327672

Oil Filter

85CF, 95XF



Suffix Key; OE = Original Equipment, R = Reconditioned Part
OEM = Original Equipment Manufacturer, ALT = Alternative Supplier Part

OE Numbers used for Cross Reference Purposes Only

sales@direct-sourcing-solutions.com www.direct-sourcing-solutions.com

Tel; +44 (0) 1653 668179 Fax; +44 (0) 1905 507755

Section: 1, Pg: 3

Direct Sourcing Solutions

DAF Catalogue 5.14.1

Section 1: Engine



1

Filters, Oil

501009

1345332

Oil Filter

75CF, CF75



510004

1397765

Oil Filter, Paper Type

CF75, CF75IV, CF85, XF95



510002

1397764 1446645 1739447

Oil Filter, Paper Type

75CF, 85CF, CF75, CF75IV, CF85, CF85IV, XF95



510006

1643072

Centrifugal Oil Filter

CF85IV, XF95, XF105



510005

1643070

Oil Filter, Paper Type

CF85IV, XF95, XF105



Suffix Key; OE = Original Equipment, R = Reconditioned Part

OEM = Original Equipment Manufacturer, ALT = Alternative Supplier Part

OE Numbers used for Cross Reference Purposes Only

sales@direct-sourcing-solutions.com www.direct-sourcing-solutions.com

Tel; +44 (0) 1653 668179 Fax; +44 (0) 1905 507755

Section: 1, Pg: 4

Direct Sourcing Solutions

DAF Catalogue 5.14.1

Section 1: Engine



Filters, Fuel

501025

1318695 247138 247139

Fuel Filter

F65, F75, F85, F95



530008

1618993

Fuel Filter

65CF, 85CF, LF45, LF55, CF65



530007

1437070

Fuel Filter

65CF, 85CF, LF45, LF55, CF65



530006

1399760

Fuel Filter

65CF, LF45, LF55, CF65



530005

1397766 1397763 1784782

Fuel Filter

75CF, 85CF, CF75, CF85, XF95



1

Suffix Key; OE = Original Equipment, R = Reconditioned Part

OEM = Original Equipment Manufacturer, ALT = Alternative Supplier Part

OE Numbers used for Cross Reference Purposes Only

sales@direct-sourcing-solutions.com www.direct-sourcing-solutions.com

Tel; +44 (0) 1653 668179 Fax; +44 (0) 1905 507755

Section: 1, Pg: 5

Direct Sourcing Solutions

DAF Catalogue 5.14.1

Section 1: Engine



1

Filters, Fuel

530004

1699168

Fuel Filter

CF75IV, CF85IV, XF95, XF105



530011

1433649

Fuel Filter, Canister Type

CF75, CF75IV, CF85, CF85IV, XF95, XF105



530009

1811391 1450184

Fuel Filter, Paper Type

CF85, XF95



Suffix Key; OE = Original Equipment, R = Reconditioned Part

OEM = Original Equipment Manufacturer, ALT = Alternative Supplier Part

OE Numbers used for Cross Reference Purposes Only

sales@direct-sourcing-solutions.com www.direct-sourcing-solutions.com

Tel; +44 (0) 1653 668179 Fax; +44 (0) 1905 507755

Section: 1, Pg: 6

Direct Sourcing Solutions

DAF Catalogue 5.14.1

Section 1: Engine



Filters, Miscellaneous

510013

1686587

AD Blue Air Filter

LF45, LF45IV, LF55, LF55IV, CF65IV, CF75IV, CF85IV, XF95, XF105



1

--	--

--	--

--	--

--	--

Suffix Key; OE = Original Equipment, R = Reconditioned Part

OEM = Original Equipment Manufacturer, ALT = Alternative Supplier Part

OE Numbers used for Cross Reference Purposes Only

sales@direct-sourcing-solutions.com www.direct-sourcing-solutions.com

Tel; +44 (0) 1653 668179 Fax; +44 (0) 1905 507755

Section: 1, Pg: 7

Direct Sourcing Solutions

DAF Catalogue 5.14.1

Section 1: Engine



Rocker Cover Gaskets

1

510016

1306547 1361567

Rocker Cover Gasket

85CF, 95XF

2 x Required

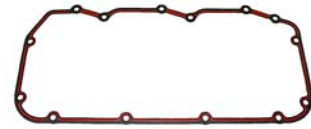

Suffix Key; OE = Original Equipment, R = Reconditioned Part

OEM = Original Equipment Manufacturer, ALT = Alternative Supplier Part

OE Numbers used for Cross Reference Purposes Only

sales@direct-sourcing-solutions.com www.direct-sourcing-solutions.com

Tel; +44 (0) 1653 668179 Fax; +44 (0) 1905 507755

Section: 1, Pg: 8



Cylinder Head Gaskets

510031

1408329

Cylinder Head Set

LF45, LF55, CF65

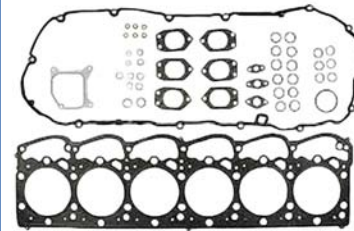

510020

683494 683532

Cylinder Head Set

CF85, XF95

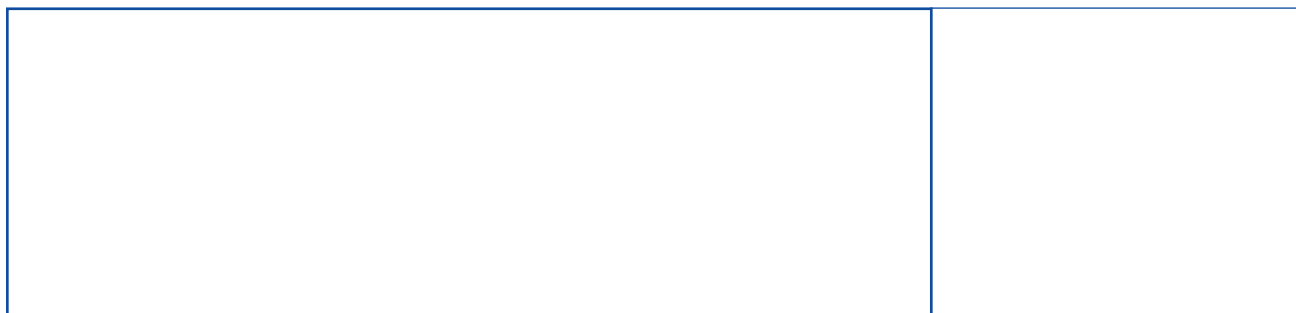
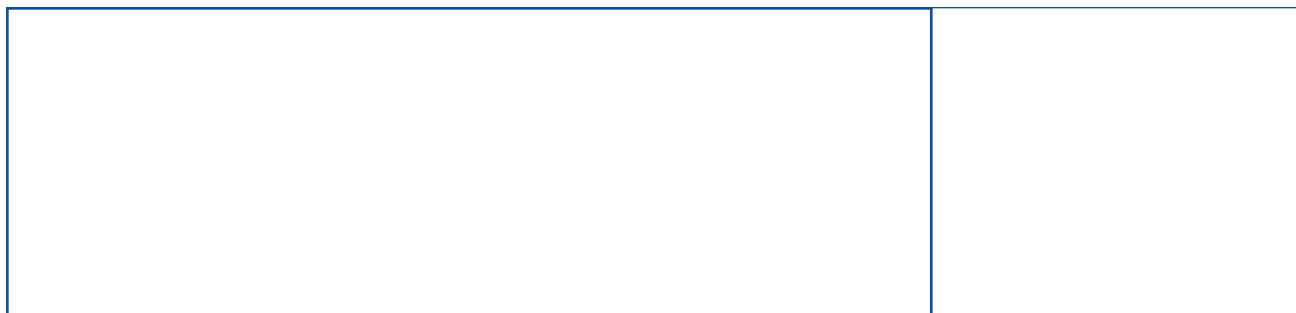
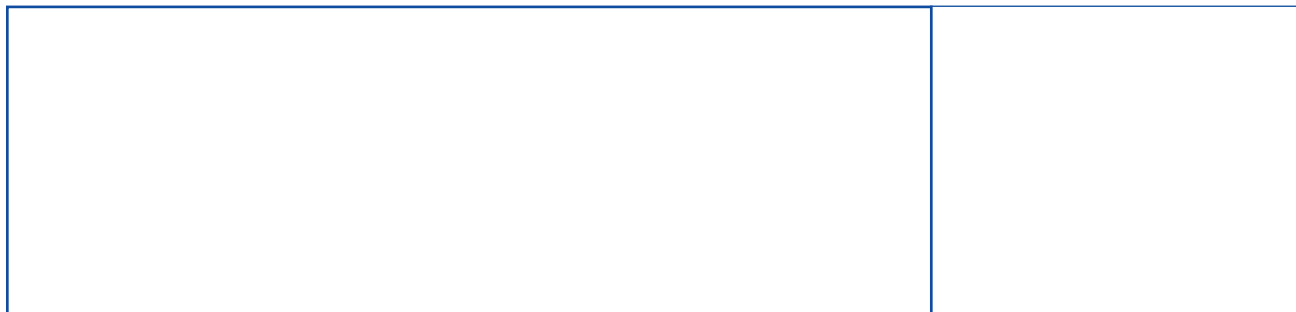

Suffix Key; OE = Original Equipment, R = Reconditioned Part

OEM = Original Equipment Manufacturer, ALT = Alternative Supplier Part

OE Numbers used for Cross Reference Purposes Only

sales@direct-sourcing-solutions.com www.direct-sourcing-solutions.com

Tel; +44 (0) 1653 668179 Fax; +44 (0) 1905 507755

Section: 1, Pg: 9



Sump Gaskets And Seals

1

510022

1315381 1458701

Sump Gasket

F95, 85CF, 95XF, CF85, CF85IV, XF95



510026

1403610 1703012

Sump Gasket

LF45, CF65



510021

1330670 1458702

Sump Gasket

CF75, CF75IV, 6/8/11 Ltr

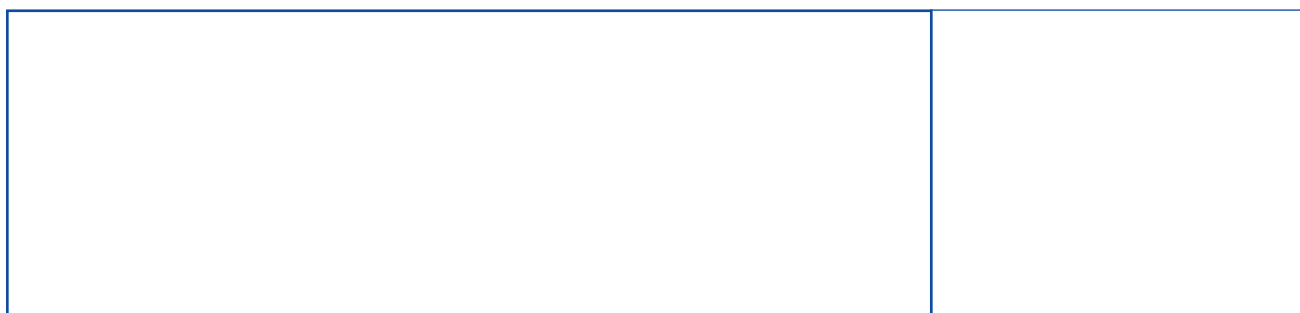
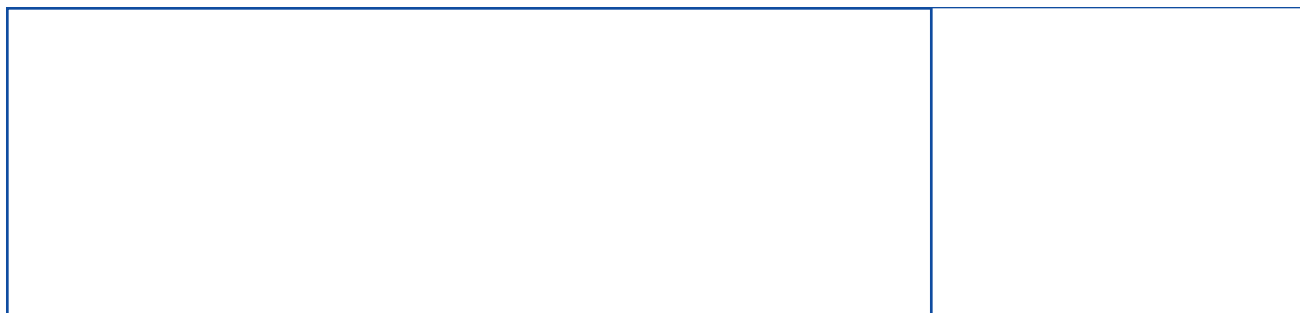

Suffix Key; OE = Original Equipment, R = Reconditioned Part

OEM = Original Equipment Manufacturer, ALT = Alternative Supplier Part

OE Numbers used for Cross Reference Purposes Only

sales@direct-sourcing-solutions.com www.direct-sourcing-solutions.com

Tel; +44 (0) 1653 668179 Fax; +44 (0) 1905 507755

Section: 1, Pg: 10

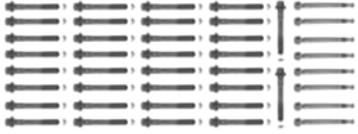

Cylinder Heads And Bolts

<p>510023 N/A Cylinder Head Bolt Set 85CF, 95XF Set For 1 Cylinder Head</p>	

Suffix Key; OE = Original Equipment, R = Reconditioned Part

OEM = Original Equipment Manufacturer, ALT = Alternative Supplier Part

OE Numbers used for Cross Reference Purposes Only

sales@direct-sourcing-solutions.com www.direct-sourcing-solutions.com

Tel; +44 (0) 1653 668179 Fax; +44 (0) 1905 507755



Exhaust Manifold Gaskets

1

<p>530012 1639810 Exhaust Manifold Gasket CF85, CF85IV, XF95, XF105</p>	



Flywheels And Bearings

<p>501051 1314029 1249198 Flywheel Assembly F85, F95, 85CF, 95XF</p>	
<p>510017 1442512 1333196 Flywheel Assembly F95, 85CF, 95XF, CF85, CF85IV, XF95</p>	
<p>510024 1672074 1697674 Flywheel Assembly, 430mm CF85IV, XF95, XF105</p>	
<p>504012 661319 Spigot Bearing F800, F1000, F1100, F1300, F1600, F1700, F1800, F1900, F2100, F2300, F2500, F2700, F2800, F2900, F3200, F3300, F3600, N2800, F75, F85, F95, 75CF, 85CF, 95XF, CF75, CF85, CF85IV, XF95, XF105</p>	
<p>510027 1374298 Flywheel Flanged Bolt, M16 x 60 10.9 F85, F95, 85CF, 95XF, CF85, CF85IV, XF95 10 x Required</p>	

Suffix Key; OE = Original Equipment, R = Reconditioned Part

OEM = Original Equipment Manufacturer, ALT = Alternative Supplier Part

OE Numbers used for Cross Reference Purposes Only

sales@direct-sourcing-solutions.com www.direct-sourcing-solutions.com

Tel; +44 (0) 1653 668179 Fax; +44 (0) 1905 507755

Section: 1, Pg: 13

Direct Sourcing Solutions

DAF Catalogue 5.14.1

Section 1: Engine



Flywheel Ring Gear

1

510025

298355 1313871

Flywheel Ring Gear, 458mm

F75, F85, F95, 85CF, 95XF, CF85, BUS



501053

1314188

Flywheel Ring Gear

F75, F95, 75CF, 85CF, 95XF, CF75, CF75IV, CF85, CF85IV, XF95



510030

1606305

Flywheel Ring Gear

CF85IV, XF95, XF105



Suffix Key; OE = Original Equipment, R = Reconditioned Part

OEM = Original Equipment Manufacturer, ALT = Alternative Supplier Part

OE Numbers used for Cross Reference Purposes Only

sales@direct-sourcing-solutions.com www.direct-sourcing-solutions.com

Tel; +44 (0) 1653 668179 Fax; +44 (0) 1905 507755

Section: 1, Pg: 14



Oil Coolers, Gaskets And Associated Parts

<p>501054 1667565 1387035 Oil Cooler CF85, XF95</p>	<p style="text-align: center;">Alternatives; 501054OEM</p> 
--	---

<p>510032OEM 1643074 1780140 Oil Cooler XF105</p>	
--	---

<p>510019 1368341 271134 Oil Cooler Seal F75, 75CF, 85CF, 95XF, CF75, CF75IV, CF85, CF85IV, XF95 6 x Required For 501054 & 501054OEM</p>	
--	---

--	--

--	--



Engine Mountings

1

510018

1664140 78015

Engine Mounting, Rear

F95, 75CF, 85CF, 95XF, CF75, CF85, CF85IV, XF95



Suffix Key; OE = Original Equipment, R = Reconditioned Part

OEM = Original Equipment Manufacturer, ALT = Alternative Supplier Part

OE Numbers used for Cross Reference Purposes Only

sales@direct-sourcing-solutions.com www.direct-sourcing-solutions.com

Tel; +44 (0) 1653 668179 Fax; +44 (0) 1905 507755

Section: 1, Pg: 16

Direct Sourcing Solutions

DAF Catalogue 5.14.1



1

This Page Is Intentionally Left Blank

Suffix Key; OE = Original Equipment, R = Reconditioned Part
OEM = Original Equipment Manufacturer, ALT = Alternative Supplier Part

OE Numbers used for Cross Reference Purposes Only

sales@direct-sourcing-solutions.com www.direct-sourcing-solutions.com

Tel; +44 (0) 1653 668179 Fax; +44 (0) 1905 507755

Direct Sourcing Solutions

DAF Catalogue 5.14.1

2: Cooling Index



2

Cooling Fans And Ancillary Parts Pg: 9-10

Expansion Tanks And Associated Parts Pg: 3-4

Fan Belt Tensioners,
Rollers And Bearings Pg: 12

Fan/Drive Belts Pg: 11

Hoses And Parts; Bottom Hoses Pg: 7

Hoses And Parts; Top Hoses Pg: 6

Intercoolers Pg: 2

Radiators Pg: 1

Switches And Sensors Pg: 13

Thermostats And Seals Pg: 8

Water Pumps And Associated Parts Pg: 5

Suffix Key; OE = Original Equipment, R = Reconditioned Part
OEM = Original Equipment Manufacturer, ALT = Alternative Supplier Part

OE Numbers used for Cross Reference Purposes Only

sales@direct-sourcing-solutions.com www.direct-sourcing-solutions.com

Tel; +44 (0) 1653 668179 Fax; +44 (0) 1905 507755

Direct Sourcing Solutions

DAF Catalogue 5.14.1

Section 2: Cooling



Radiators

520012OEM

1326966 1617340 1858772

Radiator

F95, 95XF, XF95



520010

1403273 1407721 1405176

Radiator

LF45



520011

1405413 1407725

Radiator

LF55



520009

1627415 1434917 1371372 3222643

Radiator

CF85



520013OEM

1674136 1692332 1739550 1856628 1861737

Radiator

XF95 2005>, XF105



2

Suffix Key; OE = Original Equipment, R = Reconditioned Part

OEM = Original Equipment Manufacturer, ALT = Alternative Supplier Part

OE Numbers used for Cross Reference Purposes Only

sales@direct-sourcing-solutions.com www.direct-sourcing-solutions.com

Tel; +44 (0) 1653 668179 Fax; +44 (0) 1905 507755

Section: 2, Pg: 1



Intercoolers

520030

1327673 1619667

Intercooler

95XF, XF95, XF105

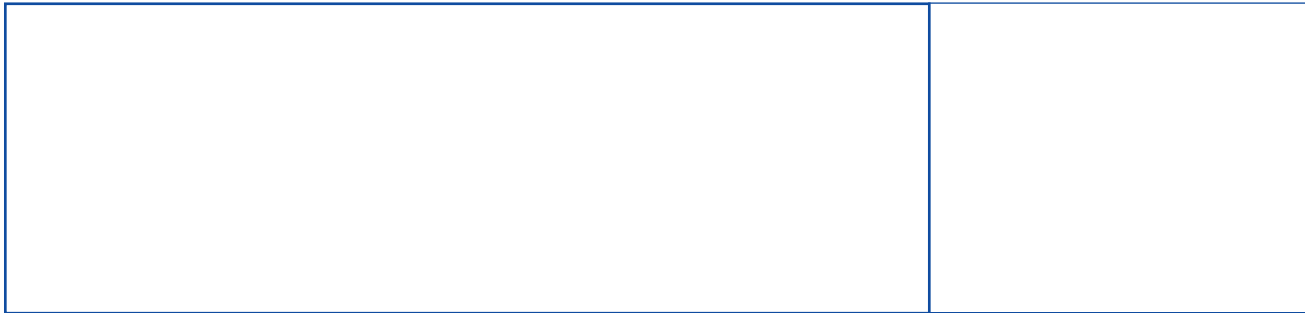
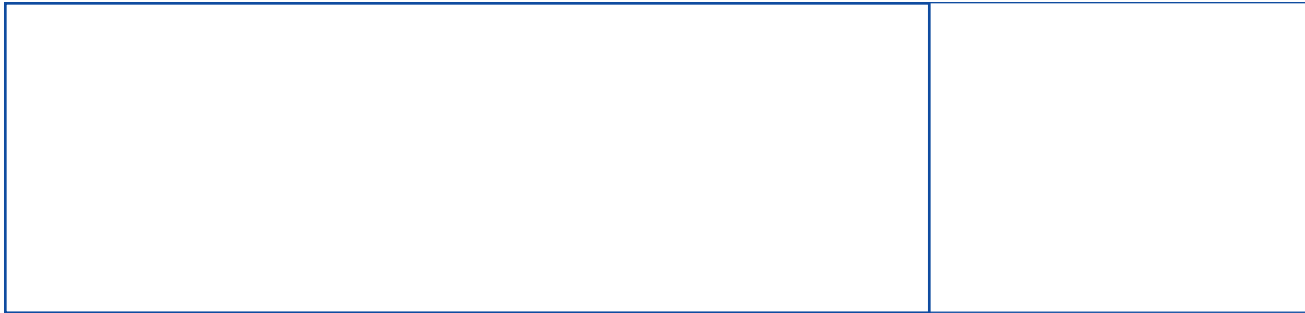

Suffix Key; OE = Original Equipment, R = Reconditioned Part

OEM = Original Equipment Manufacturer, ALT = Alternative Supplier Part

OE Numbers used for Cross Reference Purposes Only

sales@direct-sourcing-solutions.com www.direct-sourcing-solutions.com

Tel; +44 (0) 1653 668179 Fax; +44 (0) 1905 507755

Section: 2, Pg: 2



Expansion Tanks And Associated Parts

<p>520006 1307627 295662 Header Tank Cap F65, F75, F85, F95, 65CF, 75CF, 85CF, 95XF, XF95</p>	
<p>520007 1371331 1615509 1657336 1743703 Header Tank Cap 75CF, 85CF, CF65, CF65IIL, CF65IV, CF75, CF75IV, CF85, CF85IV</p>	
<p>520003OEM Alternatives; 520003 1295910 1607794 393391 Header Tank F95, 95XF, LF45, XF95 Filler And Pressure Caps At Same End Of The Tank</p>	
<p>520018 1404524 1700772 Header Tank LF45, LF45IV, LF55, LF55IV</p>	
<p>520004 1404867 1702252 Header Tank RHD LF45IV, LF55IV</p>	



Expansion Tanks And Associated Parts

520002

1371329 1660859

Header Tank

CF65, CF75, CF85



520005

1626237

Header Tank

XF95, XF105

Filler And Pressure Caps At Opposite Ends Of The Tank



520016OEM

1684655

Header Tank

XF95

Filler And Pressure Caps At Same End Of The Tank



Suffix Key; OE = Original Equipment, R = Reconditioned Part

OEM = Original Equipment Manufacturer, ALT = Alternative Supplier Part

OE Numbers used for Cross Reference Purposes Only

sales@direct-sourcing-solutions.com www.direct-sourcing-solutions.com

Tel; +44 (0) 1653 668179 Fax; +44 (0) 1905 507755

Section: 2, Pg: 4



Water Pumps And Associated Parts

520015

683225 1609871 683586

Water Pump

F95, 85CF, 95XF, XF95



520019

1609853 1399150 683579

Water Pump

85CF, CF85, CF85IV, XF95



520031

1399689 C3286278 CBU1131 CBU2148 CBU2714

Water Pump

LF45, LF55



520022

1664762 1778280 1828162

Water Pump

CF85IV, XF95, XF105

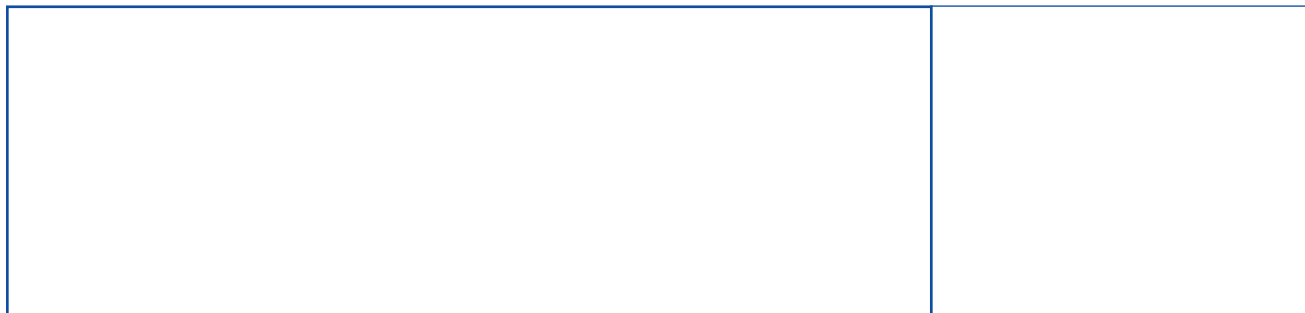

Suffix Key; OE = Original Equipment, R = Reconditioned Part

OEM = Original Equipment Manufacturer, ALT = Alternative Supplier Part

OE Numbers used for Cross Reference Purposes Only

sales@direct-sourcing-solutions.com www.direct-sourcing-solutions.com

Tel; +44 (0) 1653 668179 Fax; +44 (0) 1905 507755

Section: 2, Pg: 5



Hoses And Parts; Top Hoses

<p>520036 1399815 Top Radiator Hose XF95</p>	

Suffix Key; OE = Original Equipment, R = Reconditioned Part

OEM = Original Equipment Manufacturer, ALT = Alternative Supplier Part

OE Numbers used for Cross Reference Purposes Only

sales@direct-sourcing-solutions.com www.direct-sourcing-solutions.com

Tel; +44 (0) 1653 668179 Fax; +44 (0) 1905 507755

Section: 2, Pg: 6



Hoses And Parts; Bottom Hoses

<p>520035 1440636 Bottom Radiator Hose XF95</p>	



Thermostats And Seals

2

520028

1439845 1661375

Thermostat 87 Degrees

F800, F1000, F1100, F1300, F1600, F1700, F1800, F1900, F2100, F2300, F2500, F2700, 75CF, 85CF, CF75, CF75IV, CF85, CF85IV, XF95, XF105



520027

1295977 1778819

Thermostat 75 Degrees

F85, F95, CF75IV, CF85, XF95



--	--

--	--

--	--

Suffix Key; OE = Original Equipment, R = Reconditioned Part

OEM = Original Equipment Manufacturer, ALT = Alternative Supplier Part

OE Numbers used for Cross Reference Purposes Only

sales@direct-sourcing-solutions.com www.direct-sourcing-solutions.com

Tel; +44 (0) 1653 668179 Fax; +44 (0) 1905 507755

Section: 2, Pg: 8



Cooling Fans And Ancillary Parts

520023

1306244 1348775

Viscous Fan Clutch

F75, 75CF



520024

1377197

Viscous Fan Clutch

F85, 85CF



520025

1441774 1449677 1666157 1680937

Viscous Fan Clutch

85CF, CF85



520008OEM

1806713 1742083 1916598

Viscous Fan Clutch

CF85IV, XF105



520029

1677080 1693441 1697677 1732274 1806712

Viscous Fan Clutch

CF85IV, XF105



Suffix Key; OE = Original Equipment, R = Reconditioned Part

OEM = Original Equipment Manufacturer, ALT = Alternative Supplier Part

OE Numbers used for Cross Reference Purposes Only

sales@direct-sourcing-solutions.com www.direct-sourcing-solutions.com

Tel; +44 (0) 1653 668179 Fax; +44 (0) 1905 507755

Section: 2, Pg: 9



Cooling Fans And Ancillary Parts

520026

1427573 1666098 1680935

Viscous Fan Clutch

XF95

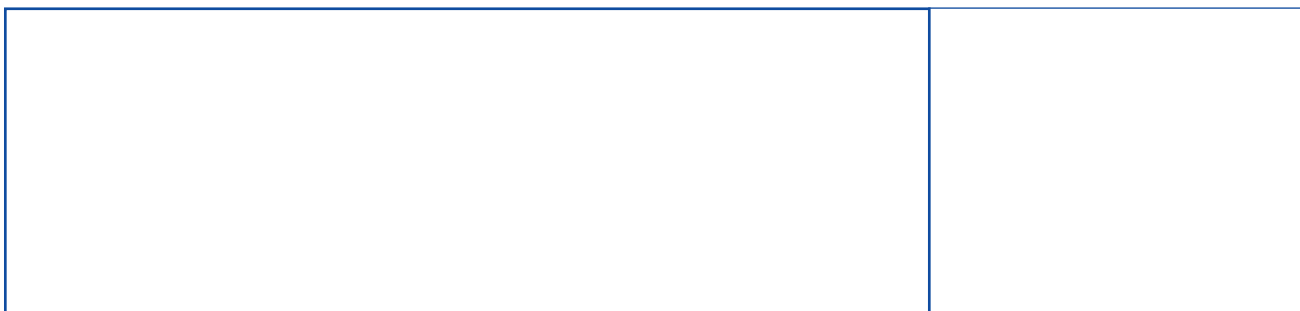
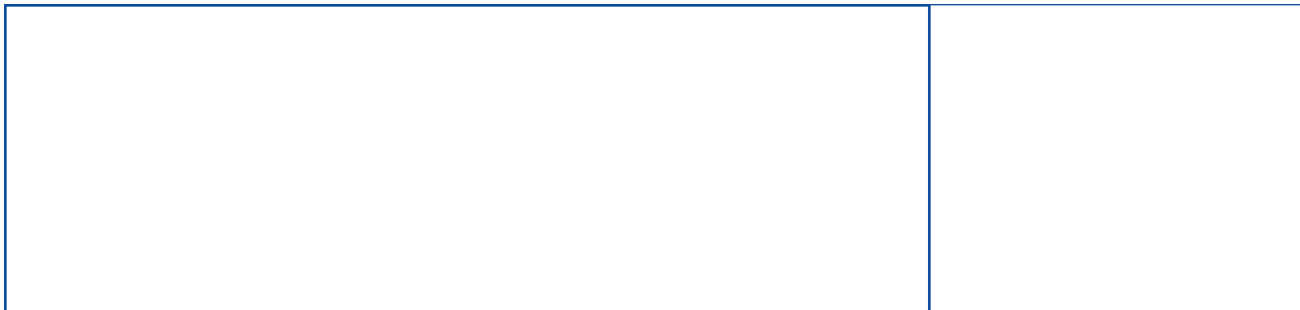
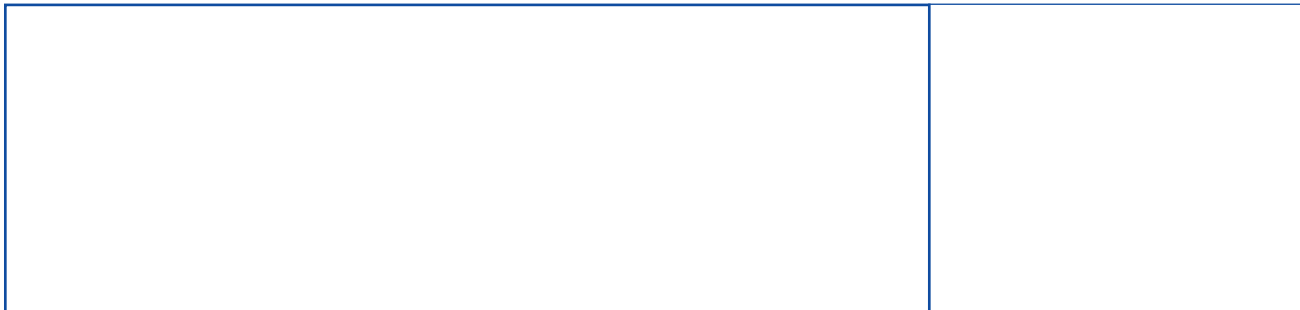

Suffix Key; OE = Original Equipment, R = Reconditioned Part

OEM = Original Equipment Manufacturer, ALT = Alternative Supplier Part

OE Numbers used for Cross Reference Purposes Only

sales@direct-sourcing-solutions.com www.direct-sourcing-solutions.com

Tel; +44 (0) 1653 668179 Fax; +44 (0) 1905 507755

Section: 2, Pg: 10

Direct Sourcing Solutions

DAF Catalogue 5.14.1

Section 2: Cooling



Fan/Drive Belts

Please Note: In Order To Identify The Correct Replacement Belt, It Is Advisable To Examine The Old Belt For Any OE Part Number, Or Similar References

2

520017

1661948

Multi Rib Belt

CF85IV, XF95, XF105

9PK 1380



520020

1458919 1638698 1812162

Multi Rib Belt

7PK 1753



Suffix Key; OE = Original Equipment, R = Reconditioned Part

OEM = Original Equipment Manufacturer, ALT = Alternative Supplier Part

OE Numbers used for Cross Reference Purposes Only

sales@direct-sourcing-solutions.com www.direct-sourcing-solutions.com

Tel; +44 (0) 1653 668179 Fax; +44 (0) 1905 507755

Section: 2, Pg: 11



Switches And Sensors

520021

1371332 1624783 1740758

Coolant Level Sensor

75CF, 85CF, CF65, CF65II, CF65IV, CF75, CF75IV, CF85, CF85IV



Suffix Key; OE = Original Equipment, R = Reconditioned Part

OEM = Original Equipment Manufacturer, ALT = Alternative Supplier Part

OE Numbers used for Cross Reference Purposes Only

sales@direct-sourcing-solutions.com www.direct-sourcing-solutions.com

Tel; +44 (0) 1653 668179 Fax; +44 (0) 1905 507755

Section: 2, Pg: 13

Direct Sourcing Solutions

DAF Catalogue 5.14.1

3: Fuel Index



Filters, Fuel

Pg: 1-2

Fuel Tank Caps And Gaskets

Pg: 4

Fuel Tanks

Pg: 3

3

Suffix Key; OE = Original Equipment, R = Reconditioned Part
OEM = Original Equipment Manufacturer, ALT = Alternative Supplier Part

OE Numbers used for Cross Reference Purposes Only

sales@direct-sourcing-solutions.com www.direct-sourcing-solutions.com

Tel; +44 (0) 1653 668179 Fax; +44 (0) 1905 507755

Direct Sourcing Solutions

DAF Catalogue 5.14.1

Section 3: Fuel



Filters, Fuel

501025

1318695 247138 247139

Fuel Filter

F65, F75, F85, F95



530008

1618993

Fuel Filter

65CF, 85CF, LF45, LF55, CF65



530007

1437070

Fuel Filter

65CF, 85CF, LF45, LF55, CF65



530006

1399760

Fuel Filter

65CF, LF45, LF55, CF65



530005

1397766 1784782 1397763

Fuel Filter

75CF, 85CF, CF75, CF85, XF95



3

Suffix Key; OE = Original Equipment, R = Reconditioned Part

OEM = Original Equipment Manufacturer, ALT = Alternative Supplier Part

OE Numbers used for Cross Reference Purposes Only

sales@direct-sourcing-solutions.com www.direct-sourcing-solutions.com

Tel; +44 (0) 1653 668179 Fax; +44 (0) 1905 507755

Section: 3, Pg: 1

Direct Sourcing Solutions

DAF Catalogue 5.14.1

Section 3: Fuel



Filters, Fuel

530004

1699168

Fuel Filter

CF75IV, CF85IV, XF95, XF105



3

530011

1433649

Fuel Filter, Canister Type

CF75, CF75IV, CF85, CF85IV, XF95, XF105



530009

1811391 1450184

Fuel Filter, Paper Type

CF85, CF85IV, XF95

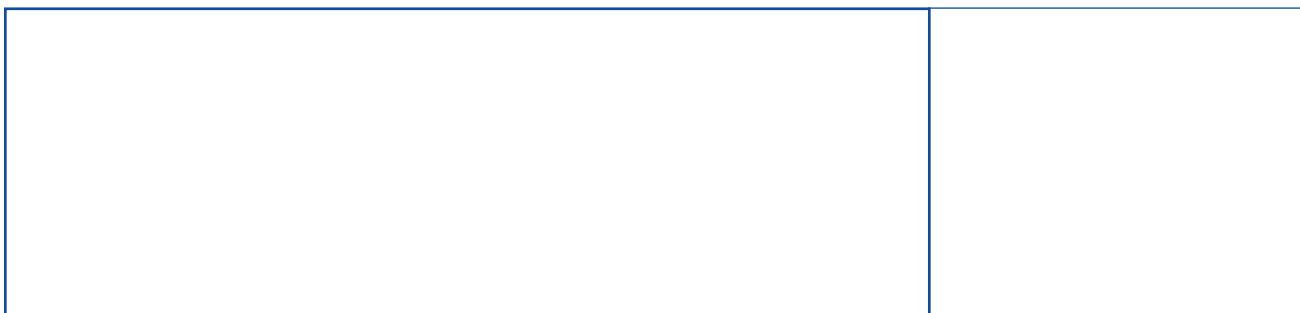
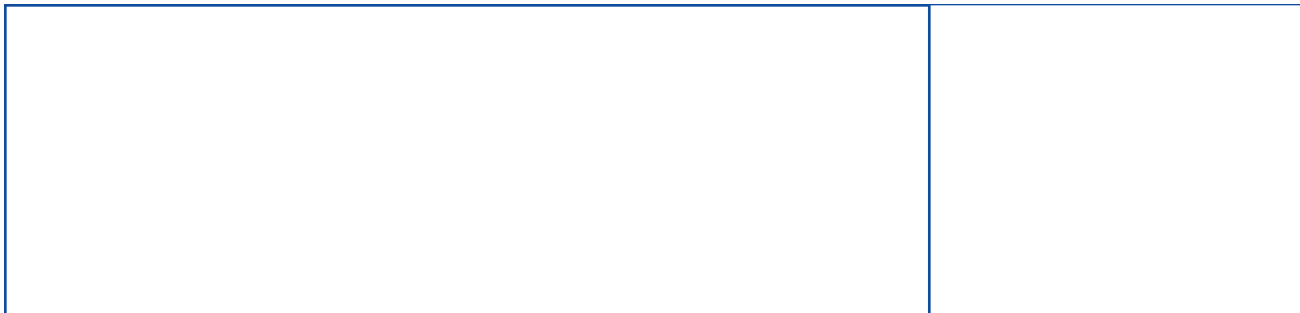

Suffix Key; OE = Original Equipment, R = Reconditioned Part

OEM = Original Equipment Manufacturer, ALT = Alternative Supplier Part

OE Numbers used for Cross Reference Purposes Only

sales@direct-sourcing-solutions.com www.direct-sourcing-solutions.com

Tel; +44 (0) 1653 668179 Fax; +44 (0) 1905 507755

Section: 3, Pg: 2



Fuel Tanks

<p>530015 1403464 Fuel Tank (Steel) - 123Ltr LF45, LF55, CF65</p>	
<p>530014 1403509 Fuel Tank (Steel) - 150Ltr LF45, LF55, CF65</p>	
<p>530016 1403465 Fuel Tank (Steel) - 168Ltr LF45, LF55, CF65</p>	
<p>530017 1403466 Fuel Tank (Steel) - 200Ltr LF45, LF55, CF65</p>	



Fuel Tank Caps And Gaskets

530003

699970 1295661 1697734 1315785

Locking Fuel Cap

65CF, 75CF, 85CF, 95XF, LF55, CF65, CF75, CF75IV, CF85, CF85IV, XF95, XF105
80mm Vented



3

530001

1686345 1742568

AD Blue Locking Cap



Suffix Key; OE = Original Equipment, R = Reconditioned Part

OEM = Original Equipment Manufacturer, ALT = Alternative Supplier Part

OE Numbers used for Cross Reference Purposes Only

sales@direct-sourcing-solutions.com www.direct-sourcing-solutions.com

Tel; +44 (0) 1653 668179 Fax; +44 (0) 1905 507755

Section: 3, Pg: 4

Direct Sourcing Solutions

DAF Catalogue 5.14.1



3

This Page Is Intentionally Left Blank

Suffix Key; OE = Original Equipment, R = Reconditioned Part
OEM = Original Equipment Manufacturer, ALT = Alternative Supplier Part

OE Numbers used for Cross Reference Purposes Only

sales@direct-sourcing-solutions.com www.direct-sourcing-solutions.com

Tel; +44 (0) 1653 668179 Fax; +44 (0) 1905 507755

Direct Sourcing Solutions

DAF Catalogue 5.14.1

5: Engine Control Index



Exhaust Brake Valves And Cylinders Pg: 1

5

Suffix Key; OE = Original Equipment, R = Reconditioned Part
OEM = Original Equipment Manufacturer, ALT = Alternative Supplier Part

OE Numbers used for Cross Reference Purposes Only

sales@direct-sourcing-solutions.com www.direct-sourcing-solutions.com

Tel; +44 (0) 1653 668179 Fax; +44 (0) 1905 507755



Exhaust Brake Valves And Cylinders

530002

1389428

Exhaust Brake Cylinder

F65, F75, F95, 65CF, 75CF, 85CF, 95XF, CF75, CF85, CF85IV, XF95, XF105



Suffix Key; OE = Original Equipment, R = Reconditioned Part

OEM = Original Equipment Manufacturer, ALT = Alternative Supplier Part

OE Numbers used for Cross Reference Purposes Only

sales@direct-sourcing-solutions.com www.direct-sourcing-solutions.com

Tel; +44 (0) 1653 668179 Fax; +44 (0) 1905 507755

Section: 5, Pg: 1

Direct Sourcing Solutions

DAF Catalogue 5.14.1

6: Clutch Index



Clutch Forks And Associated Parts	Pg: 5
Clutch Kits And Associated Parts	Pg: 6
Clutch Servos And Associated Parts	Pg: 3-4
Master Cylinders And Associated Parts	Pg: 2
Pedal Rubbers, Return Springs And Linkage Parts	Pg: 1

Suffix Key; OE = Original Equipment, R = Reconditioned Part
OEM = Original Equipment Manufacturer, ALT = Alternative Supplier Part

OE Numbers used for Cross Reference Purposes Only

sales@direct-sourcing-solutions.com www.direct-sourcing-solutions.com

Tel; +44 (0) 1653 668179 Fax; +44 (0) 1905 507755



Pedal Rubbers, Return Springs And Linkage Parts

<p>540004 82481 Clutch Pedal Rubber CF85, XF95</p>	



Master Cylinders And Associated Parts

504123

1395485 1334482

Clutch Master Cylinder

F75, F95, 75CF, 85CF, 95XF, CF75, CF75IV, CF85, CF85IV, XF95, XF105



504013

1291190

Clutch Master Cylinder

F95, 75CF, 85CF, 95XF, XF95

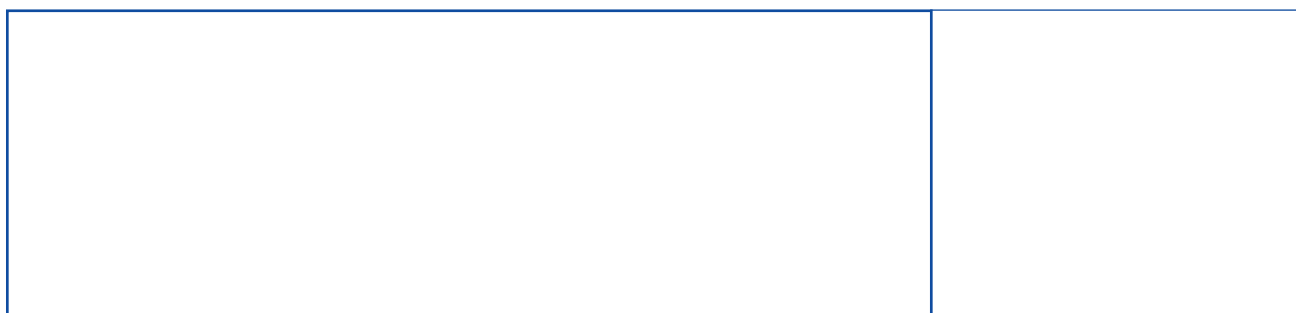
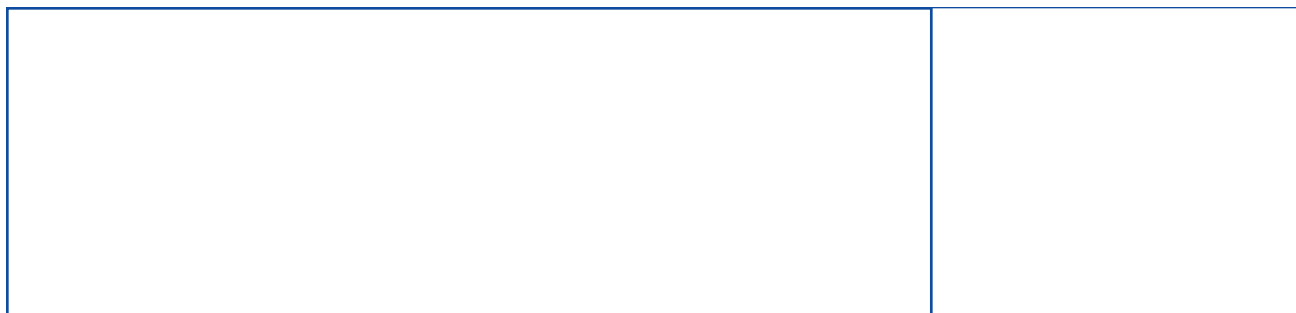
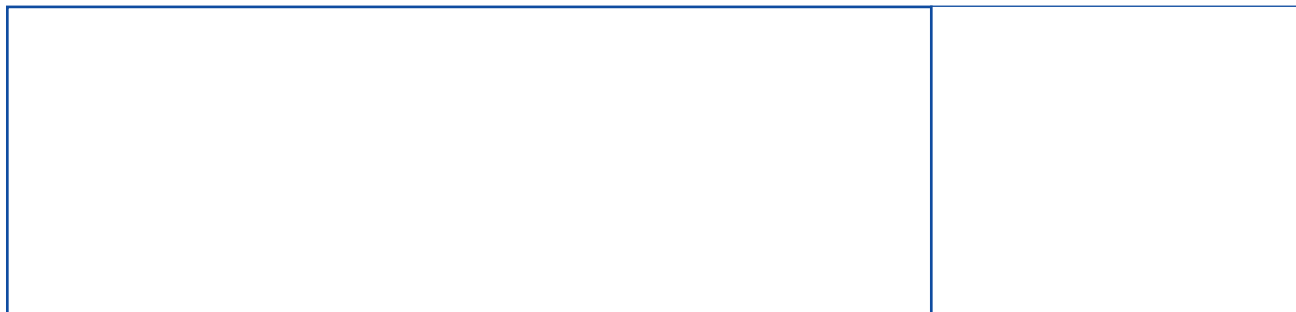

Suffix Key; OE = Original Equipment, R = Reconditioned Part

OEM = Original Equipment Manufacturer, ALT = Alternative Supplier Part

OE Numbers used for Cross Reference Purposes Only

sales@direct-sourcing-solutions.com www.direct-sourcing-solutions.com

Tel; +44 (0) 1653 668179 Fax; +44 (0) 1905 507755

Section: 6, Pg: 2



Clutch Servos And Associated Parts

504001

1443520 1242616

Clutch Servo

F1700, F1800, F1900, F2100, F2300, F2500, F2700, F2800, F2900, F3300, F3600, F65, 65CF



504008

1443530 622508

Clutch Servo

F75, F85, F95, 85CF



504007

1443521 377009

Clutch Servo

F75, 75CF, CF75, CF75IV



504150

1443522 1397120 1443524 628259

Clutch Servo

F75, F95, 75CF, 85CF, 95XF, CF75, CF85, XF95



540017

1447248 1815943

Clutch Servo

CF75, CF85, XF95, XF105



Suffix Key; OE = Original Equipment, R = Reconditioned Part

OEM = Original Equipment Manufacturer, ALT = Alternative Supplier Part

OE Numbers used for Cross Reference Purposes Only

sales@direct-sourcing-solutions.com www.direct-sourcing-solutions.com

Tel; +44 (0) 1653 668179 Fax; +44 (0) 1905 507755

Section: 6, Pg: 3



Clutch Servos And Associated Parts

540003OEM

1613228

Clutch Servo

CF75IV, CF85IV, XF95, XF105



Suffix Key; OE = Original Equipment, R = Reconditioned Part

OEM = Original Equipment Manufacturer, ALT = Alternative Supplier Part

OE Numbers used for Cross Reference Purposes Only

sales@direct-sourcing-solutions.com www.direct-sourcing-solutions.com

Tel; +44 (0) 1653 668179 Fax; +44 (0) 1905 507755

Section: 6, Pg: 4



Clutch Forks And Associated Parts

<p>540006 1392537 1391637 1316304 Clutch Fork F75, F85, F95, 75CF, 85CF, 95XF, CF75, CF85, XF95</p>	



Clutch Kits And Associated Parts

504012

661319

Spigot Bearing

F800, F1000, F1100, F1300, F1600, F1700, F1800, F1900, F2100, F2300, F2500, F2700, F2800, F2900, F3200, F3300, F3600, N2800, F75, F85, F95, 75CF, 85CF, 95XF, CF75, CF85, CF85IV, XF95, XF105



540007

Clutch Kit 430mm

75CF, 85CF, CF75, CF85, XF95



540002

1625968R 1625971R 1628626R 1628627R 1789280R 1789281R

Clutch Kit 430mm

75CF, 85CF, CF75, CF85, XF95



540018

1736890

Clutch Kit 395mm

LF45, LF55, CF65



540019

1740017R 1808123R 1815112R 1817774R

Clutch Kit 362mm

LF45



Suffix Key; OE = Original Equipment, R = Reconditioned Part

OEM = Original Equipment Manufacturer, ALT = Alternative Supplier Part

OE Numbers used for Cross Reference Purposes Only

sales@direct-sourcing-solutions.com www.direct-sourcing-solutions.com

Tel; +44 (0) 1653 668179 Fax; +44 (0) 1905 507755

Section: 6, Pg: 6

Direct Sourcing Solutions

DAF Catalogue 5.14.1



6

This Page Is Intentionally Left Blank

Suffix Key; OE = Original Equipment, R = Reconditioned Part
OEM = Original Equipment Manufacturer, ALT = Alternative Supplier Part

OE Numbers used for Cross Reference Purposes Only

sales@direct-sourcing-solutions.com www.direct-sourcing-solutions.com

Tel; +44 (0) 1653 668179 Fax; +44 (0) 1905 507755

Direct Sourcing Solutions

DAF Catalogue 5.14.1

7: Gearbox Index



Gear Lever Knobs Pg: 1

Gear Linkage Parts And Mountings Pg: 2

Oil Filters, Gaskets And Seals Pg: 3

Solenoids And Valves Pg: 4

Suffix Key; OE = Original Equipment, R = Reconditioned Part
OEM = Original Equipment Manufacturer, ALT = Alternative Supplier Part



OE Numbers used for Cross Reference Purposes Only

sales@direct-sourcing-solutions.com www.direct-sourcing-solutions.com

Tel; +44 (0) 1653 668179 Fax; +44 (0) 1905 507755



Gear Lever Knobs

<p>504603 1285258 Gear Knob Assembly F75, F85, 75CF, 85CF, CF75, CF75IV, CF85, CF85IV Vehicles With 8 Speed Gearbox</p>	
<p>504604 1285259 Gear Knob Assembly F75, F85, F95, 75CF, 85CF, 95XF, CF75, CF75IV, CF85, CF85IV, XF95, XF105 Vehicles With 16 Speed Gearbox</p>	



Gear Linkage Parts And Mountings

<p>507603 386930 Gearbox Ball Joint F65, F75, F85, F95, 65CF, 75CF, 85CF, 95XF, LF45, LF45IV, LF55, LF55IV, CF75, CF85, XF95, XF105, BUS</p>	
<p>540015 1305257 1391526 1661931 Gearbox Control Bearing 75CF, 85CF, LF55, CF65, CF75, CF85</p>	



Oil Filters, Gaskets And Seals

<p>540001 1607475 1268607 691954 Gearbox Filter F75, F85, F95, 75CF, 85CF, 95XF, CF75, CF85, XF95, XF105</p>	



Solenoids And Valves

504516

1457275 1379772 1303948 1286867

Gearbox Solenoid Valve

F65, F75, F85, F95



504514

1457276 1379776

Gearbox Solenoid Valve

95XF, CF75, CF85, XF95, XF105



540011

1386811 1670254 1734012

Gearbox Solenoid Valve

XF95, XF105



Suffix Key; OE = Original Equipment, R = Reconditioned Part

OEM = Original Equipment Manufacturer, ALT = Alternative Supplier Part

OE Numbers used for Cross Reference Purposes Only

sales@direct-sourcing-solutions.com www.direct-sourcing-solutions.com

Tel; +44 (0) 1653 668179 Fax; +44 (0) 1905 507755

Section: 7, Pg: 4

Direct Sourcing Solutions

DAF Catalogue 5.14.1



7

This Page Is Intentionally Left Blank

Suffix Key; OE = Original Equipment, R = Reconditioned Part
OEM = Original Equipment Manufacturer, ALT = Alternative Supplier Part

OE Numbers used for Cross Reference Purposes Only

sales@direct-sourcing-solutions.com www.direct-sourcing-solutions.com

Tel; +44 (0) 1653 668179 Fax; +44 (0) 1905 507755

Direct Sourcing Solutions

DAF Catalogue 5.14.1

8: Propshaft Index



Centre Bearings And Brackets Pg: 3

Propshafts Pg: 1

Universal Joints Pg: 2

Suffix Key; OE = Original Equipment, R = Reconditioned Part
OEM = Original Equipment Manufacturer, ALT = Alternative Supplier Part

OE Numbers used for Cross Reference Purposes Only

sales@direct-sourcing-solutions.com www.direct-sourcing-solutions.com

Tel; +44 (0) 1653 668179 Fax; +44 (0) 1905 507755

Direct Sourcing Solutions

DAF Catalogue 5.14.1

Section 8: Propshaft



Propshafts

<p>540016 1244408 Propshaft Inter-Axle CF75, CF85</p>	



Universal Joints

<p>540014 Alternatives; 540014OEM 1288226 1850097 Universal Joint 52 x 148mm, Grease Type F65, F75, F85, F95, 65CF, 75CF, 85CF, 95XF, LF55, CF75, CF75IV, CF85, XF95, XF105</p>	
---	--

<p>540012 Alternatives; 540012OEM 1288224 1451320 Universal Joint 48 x 135.4mm, Grease Type 75CF, CF75</p>	
--	--

<p>540010OEM 1435479 Universal Joint 57 x 152mm, Sealed For Life 85CF, CF75, CF85, CF85IV, XF95, XF105</p>	
---	--

Empty space for part description	Empty space for part image
----------------------------------	----------------------------

Empty space for part description	Empty space for part image
----------------------------------	----------------------------

Suffix Key; OE = Original Equipment, R = Reconditioned Part
 OEM = Original Equipment Manufacturer, ALT = Alternative Supplier Part

OE Numbers used for Cross Reference Purposes Only

sales@direct-sourcing-solutions.com www.direct-sourcing-solutions.com

Tel; +44 (0) 1653 668179 Fax; +44 (0) 1905 507755



Centre Bearings And Brackets

<p>540005 1298157 Centre Bearing Assembly, 55mm F65, F75, F85, F95, 65CF, 75CF, 85CF, 95XF, CF75</p>	
<p>540013 1288220 1323765 1435557 1779697 Centre Bearing Assembly, 65mm F65, 65CF, 75CF, 85CF, 95XF, CF65, CF75, CF85, XF95</p>	
<p>540009 1288242 Centre Bearing Assembly, 70mm F95, 85CF, 95XF, CF75, CF75IV, CF85, CF85IV, XF95, XF105</p>	
<p>504902 1740904 1425157 1288231 1691743 1364376 Centre Bearing Assembly, 75mm F85, F95, 85CF, 95XF, CF75, CF85, XF95</p>	

Direct Sourcing Solutions

DAF Catalogue 5.14.1

9: Rear Axle Index



Differential Oil Seals

Pg: 1

Suffix Key; OE = Original Equipment, R = Reconditioned Part
OEM = Original Equipment Manufacturer, ALT = Alternative Supplier Part

OE Numbers used for Cross Reference Purposes Only

sales@direct-sourcing-solutions.com www.direct-sourcing-solutions.com

Tel; +44 (0) 1653 668179 Fax; +44 (0) 1905 507755



Differential Oil Seals

570048

77477 538953

Pinion Oil Seal

75CF, 85CF, CF75, CF75IV, CF85, CF85IV



Suffix Key; OE = Original Equipment, R = Reconditioned Part

OEM = Original Equipment Manufacturer, ALT = Alternative Supplier Part

OE Numbers used for Cross Reference Purposes Only

sales@direct-sourcing-solutions.com www.direct-sourcing-solutions.com

Tel; +44 (0) 1653 668179 Fax; +44 (0) 1905 507755

Section: 9, Pg: 1

Direct Sourcing Solutions

DAF Catalogue 5.14.1

10: Front Axle Index



King Pin Kits And Associated Parts

Pg: 1

10

Suffix Key; OE = Original Equipment, R = Reconditioned Part
OEM = Original Equipment Manufacturer, ALT = Alternative Supplier Part

OE Numbers used for Cross Reference Purposes Only

sales@direct-sourcing-solutions.com www.direct-sourcing-solutions.com

Tel; +44 (0) 1653 668179 Fax; +44 (0) 1905 507755



King Pin Kits And Associated Parts

570002

681706

King Pin Kit (Axle Set)

F800, F1000, F1100, F1300, F1600, F1700, F1800, F1900, F2100, F2300, F2500, F2700, F65, F75, F85, F95, 65CF, 75CF, 85CF, 95XF, XF95



570003

683499

King Pin Kit (Axle Set)

65CF, 75CF, 85CF, CF65, CF65II, CF65IV, CF75, CF75IV, CF85, CF85IV, XF95, XF105



Suffix Key; OE = Original Equipment, R = Reconditioned Part

OEM = Original Equipment Manufacturer, ALT = Alternative Supplier Part

OE Numbers used for Cross Reference Purposes Only

sales@direct-sourcing-solutions.com www.direct-sourcing-solutions.com

Tel; +44 (0) 1653 668179 Fax; +44 (0) 1905 507755

Section: 10, Pg: 1

Direct Sourcing Solutions

DAF Catalogue 5.14.1

11: Wheels & Hubs Index



Hub Bearings, Front Axle Pg: 3

Hub Bearings, Rear Axle Pg: 4

Hub Caps, Nuts, Lock Tabs
And Seals - Single Wheel Pg: 5-6

Hub Caps, Nuts, Lock Tabs
And Seals - Twin Wheel Pg: 7

Hubs, Front Axle Pg: 1

Hubs, Rear Axle Pg: 2

Wheel Studs And Nuts Pg: 8

Wheel Trims Pg: 9

Suffix Key; OE = Original Equipment, R = Reconditioned Part
OEM = Original Equipment Manufacturer, ALT = Alternative Supplier Part

OE Numbers used for Cross Reference Purposes Only

sales@direct-sourcing-solutions.com www.direct-sourcing-solutions.com

Tel; +44 (0) 1653 668179 Fax; +44 (0) 1905 507755



Hubs, Front Axle

505612

1391615 1388905 1697346

Front Hub Assembly Complete With Bearing

65CF, 75CF, 85CF, LF55, LF55IV, CF65, CF65II, CF65IV, CF75, CF75IV, CF85, CF85IV, XF95, XF105



505612NB

Front Hub Without Bearing

65CF, 75CF, 85CF, LF55, LF55IV, CF65, CF65II, CF65IV, CF75, CF75IV, CF85, CF85IV, XF95, XF105

Use Bearing Kit 550002OEM



570001

1691621 1699327 1818004

Front Hub Assembly Complete With Bearing

CF65, CF65IV, CF75, CF75IV, CF85, CF85IV, XF95, XF105

Use Bearing Kit 550003OEM



570001NB

Front Hub Without Bearing

CF65, CF65IV, CF75, CF75IV, CF85, CF85IV, XF95, XF105

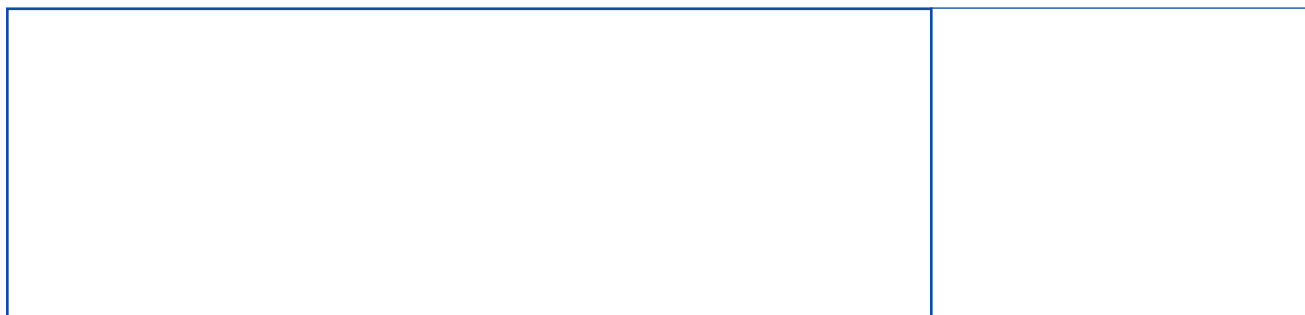

Suffix Key; OE = Original Equipment, R = Reconditioned Part

OEM = Original Equipment Manufacturer, ALT = Alternative Supplier Part

OE Numbers used for Cross Reference Purposes Only

sales@direct-sourcing-solutions.com www.direct-sourcing-solutions.com

Tel; +44 (0) 1653 668179 Fax; +44 (0) 1905 507755

Section: 11, Pg: 1



Hubs, Rear Axle

505613

1391617 1818003 1388906

Rear Hub Assembly Complete With Bearing

65CF, 75CF, 85CF, LF55, CF65, CF65II, CF65IV, CF75, CF75IV, CF85, CF85IV, XF95, XF105



505613NB

1391617 1697347

Rear Hub Without Bearing

65CF, 75CF, 85CF, LF55, CF65, CF65II, CF65IV, CF75, CF75IV, CF85, CF85IV, XF95, XF105



550001

1657637 1812161

Rear Hub Assembly Complete With Bearing

LF45IV, LF55IV, CF75IV, CF85IV, XF105



550001NB



Rear Hub Without Bearing

LF45IV, LF55IV, CF75IV, CF85IV, XF105







Hub Bearings, Front Axle

<p>550002OEM Alternatives; 550002 1801495 Front Wheel Bearing Kit 65CF, 75CF, 85CF, LF55, CF65, CF75, CF85, XF95, XF105</p>	
<p>570036OEM 1801592 Front Wheel Bearing Kit CF65IV, CF75IV, CF85IV, XF95, XF105</p>	







Hub Bearings, Rear Axle

<p>550039 528430 676987 Wheel Bearing Outer F65, F75, F85, F95, 65CF, 75CF, 85CF, 95XF, CF75, CF75IV, CF85, CF85IV Drum Brakes. 95mm Inner Diameter</p>	
<p>550003OEM Alternatives; 550003 1801594 Rear Wheel Bearing Kit CF65, CF75, CF85, XF95, XF105</p>	



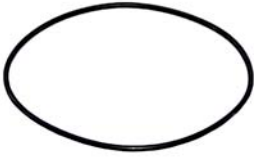

Hub Caps, Nuts, Lock Tabs And Seals - Single Wheel

<p>570030 1691965 Hub Cap CF65, CF65II, CF65IV, CF75, CF75IV, CF85, CF85IV, XF95, XF105 Use O-Ring 570052. 120.0 x 3.0mm</p>	
<p>570027 1398725 Hub O-Ring Green, Rear Hub Inner Seal 65CF, 75CF, 85CF, LF55, LF55IV, CF65, CF65II, CF65IV, CF75, CF75IV, CF85, CF85IV, XF95, XF105 110.0 x 5.0mm</p>	
<p>570052 1692506 Hub Cap O-Ring CF65, CF65II, CF65IV, CF75, CF75IV, CF85, CF85IV, XF95, XF105 To Fit Hub Cap 570030. 120.0 x 3.0mm</p>	
<p>570016 393841 Hub Cap O-Ring CF85, XF95 114.0 x 3.0mm</p>	
<p>570022 1692215 1385327 Lock Tab Washer, Front Hub 65CF, 75CF, 85CF, LF55, CF65, CF75, CF85, XF95, XF105</p>	



Hub Caps, Nuts, Lock Tabs And Seals - Single Wheel

<p>570021 1692209 Lock Tab Washer, Front Hub CF65, CF65II, CF65IV, CF75, CF75IV, CF85, CF85IV, XF95, XF105</p>	
--	---

<p>507608 1238034 Hub Seal, Single Wheel F65, F75, F85, F95, 65CF, 75CF, 85CF, 95XF</p>	
---	---

--	--

--	--

--	--



Hub Caps, Nuts, Lock Tabs And Seals - Twin Wheel

<p>570020 1385326 Lock Tab Washer, Rear Hub 65CF, 75CF, 85CF, LF55, LF55IV, CF65, CF65II, CF65IV, CF75, CF75IV, CF85, CF85IV, XF95, XF105</p>	
<p>570028 1396548 Hub Nut 65CF, 75CF, 85CF, LF55, LF55IV, CF65, CF65II, CF65IV, CF75, CF75IV, CF85, CF85IV, XF95, XF105</p>	
<p>570017 1700523 1404690 Hub Seal, Inner Rear LF45 To Fit 550003OEM</p>	



Wheel Studs And Nuts

570013

1337020 99720 99721

Front Wheel Stud M22 x 1.5

65CF, 75CF, 85CF, CF65, CF65II, CF65IV, CF75, CF75IV, CF85, CF85IV, XF95, XF105



570026

1309191 620646 620647 99730

Rear Wheel Stud

F800, F1000, F1100, F1300, F1600, F1700, F1800, F1900, F2100, F2300, F2500, F2700, F2800, F2900, F3200, F3300, F3600, N2800, F65, F75, F85, F95, 65CF, 75CF, 85CF, 95XF, LF55, LF55IV, CF65, CF65II, CF65IV, CF75, CF75IV, CF85, CF85IV, XF95, XF105, BUS



570055

1309190 1356736 890763

Rear Wheel Stud M22 x 1.5

85CF, 95XF, CF75, CF75IV, CF85, CF85IV



570014

1263487 1356737 652575

Front Wheel Nut M22 x 1.5

F2800, F2900, F3200, F3300, F3600, N2800, 75CF, 85CF, 95XF, LF55, LF55IV, CF65, CF65II, CF65IV, CF75, CF75IV, CF85, CF85IV, XF95, XF105, BUS



570015

1396606

Front Wheel Lock Nut

65CF, 75CF, 85CF, LF55IV, CF65, CF65II, CF65IV, CF75, CF75IV, CF85, CF85IV, XF95, XF105



Suffix Key; OE = Original Equipment, R = Reconditioned Part

OEM = Original Equipment Manufacturer, ALT = Alternative Supplier Part

OE Numbers used for Cross Reference Purposes Only

sales@direct-sourcing-solutions.com www.direct-sourcing-solutions.com

Tel; +44 (0) 1653 668179 Fax; +44 (0) 1905 507755

Section: 11, Pg: 8



Wheel Trims

570035

1688057

Front Wheel Trim (DAF Logo In Centre)

CF65IV, CF75, CF75IV, CF85, CF85IV, XF95, XF105



550020

505834

Front Wheel Trim (In Red Primer)

CF RANGE, XF RANGE



550024

Front Wheel Trim (In Chrome)



Suffix Key; OE = Original Equipment, R = Reconditioned Part

OEM = Original Equipment Manufacturer, ALT = Alternative Supplier Part

OE Numbers used for Cross Reference Purposes Only

sales@direct-sourcing-solutions.com www.direct-sourcing-solutions.com

Tel; +44 (0) 1653 668179 Fax; +44 (0) 1905 507755

Section: 11, Pg: 9



Air Bags	Pg: 4
Air Suspension Valves, Sensors and Switches	Pg: 5
Anti-Roll Bar Link Rods	Pg: 9
Anti-Roll Bar Bushes, Front	Pg: 10
Anti-Roll Bar Bushes, Rear	Pg: 11
Shock Absorbers	Pg: 12
Spring Pins And Bushes	Pg: 2
Springs And Associated Parts, Front	Pg: 1
Springs And Associated Parts, Rear	Pg: 3
Torque Rods And Repair Kits	Pg: 8
V-Stay Repair Kits	Pg: 7
V-Stays	Pg: 6



Springs And Associated Parts, Front

<p>570012 1401538 Spring, Single Leaf LF45, LF45IV</p>	
--	--

<p>570011 1409040 Spring, 2 x Leaf LF45</p>	
---	--

<p>570010 1700737 Spring, 2 x Leaf LF55</p>	
---	--

<p>570009 1700769 Spring, 3 x Leaf LF55</p>	
---	--

--	--



Spring Pins And Bushes

<p>570032 1357764 Front Spring Bush 65CF, 75CF, 85CF, LF55, CF65, CF75, CF75IV, CF85, CF85IV XF95, XF105 24.2 x 62.9 x 86mm</p>	
---	---

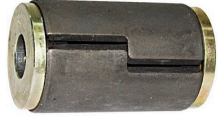
<p>570033 1368283 Front/Rear Spring Bush 65CF, 75CF, 85CF, CF65, CF75, CF75IV, CF85, CF85IV, XF95, XF105 24.2 x 62.7 x 106mm</p>	
--	---

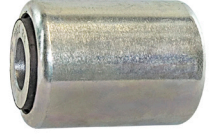
<p>570025 1671219 Front Suspension Bush CF75, CF75IV, CF85, CF85IV, XF95, XF105 24.2 x 62.7 x 86mm</p>	
--	---

--	--

--	--



Springs And Associated Parts, Rear

<p>570008 1401668 Rear Spring, Single Leaf LF45</p>	
---	--

<p>570007 1690222 Rear Spring, 6 x Leaf CF75, CF75IV, CF85, CF85IV, XF105</p>	
---	--

<p>570034 667198 Rear Spring, 6 x Leaf F75, F85, F95, 75CF, 85CF, 95XF, CF75, CF75IV, CF85, CF85IV, XF95, XF105</p>	
---	--

<p>570005 1779767 1699564 Suspension Rubber CF75, CF75IV, CF85, CF85IV, XF95, XF105</p>	
---	--

--	--



Air Bags

<p>570024 1697684 392022 Drive Axle Air Bag F75, F85, F95, 75CF, 85CF, 95XF, CF75, CF75IV, CF85, CF85IV, XF95, XF105</p>	
<p>570038 1697678 388165 Drive Axle Air Bag LF55, LF55IV, CF65, CF65II, CF65IV, CF75, CF75IV, CF85, CF85IV, XF95, XF105</p>	
<p>570023 1384594 1393920 1628472 1698435 Lift Axle Air Bag CF75, CF75IV, CF85, CF85IV, XF95, XF105</p>	
<p>570006 672991 Wire Check Strap F75, F85, F95, 75CF, 85CF, 95XF, CF75, CF85, XF95, XF105</p>	

Suffix Key; OE = Original Equipment, R = Reconditioned Part

OEM = Original Equipment Manufacturer, ALT = Alternative Supplier Part

OE Numbers used for Cross Reference Purposes Only

sales@direct-sourcing-solutions.com www.direct-sourcing-solutions.com

Tel; +44 (0) 1653 668179 Fax; +44 (0) 1905 507755

Section: 12, Pg: 4





Air Suspension Valves, Sensors And Switches

<p>570054 1365935 Ride Height Level Sensor F75, F85, F95, 65CF, 75CF, 85CF, 95XF, LF45, LF55, CF65, CF75, CF75IV, CF85, CF85IV, XF95, XF105</p>	



V-Stays

<p>570044 1620437 1793877 649819 Rear Axle V-Stay F75, F85, F95, 75CF, 85CF, 95XF, CF75, CF85 Length 602.7mm, Use Repair Kit 570051</p>	
---	---

<p>570019 1361652 1620436 1793876 Rear Axle V-Stay CF75, CF75IV, CF85, CF85IV Length 608.2mm, Tube ø 48mm, Bore 1/2 152/152mm</p>	
---	--

--	--

--	--

--	--





V-Stay Repair Kits

<p>570051 696320 V-Stay Centre Repair Kit F75, F85, F95, 75CF, 85CF, 95XF, CF75, CF75IV, CF85, CF85IV, XF95, XF105 For V-Stay 570044</p>	



Torque Rods And Repair Kits

<p>570046 1361649 1361650 1656428 267743 Torque Rod, Rear F65, F75, F85, F95, 65CF, 75CF, 85CF, 95XF, LF55, CF65, CF75, CF75IV, CF85, CF85IV, XF95, XF105 Length 611mm</p>	
--	---

<p>570031 1294251 Torque Rod F75, F85, 75CF, 85CF, CF75, CF75IV, CF85, CF85IV Length 606mm, Tube ø 40mm, Bore 1/2 19/19mm</p>	
---	---

--	--

--	--

--	--



Anti-Roll Bar Link Rods

<p>570053 1801332 1392962 Anti-Roll Bar Link Rod, Length 2028mm CF85</p>	





Anti-Roll Bar Bushes, Front

<p>570041 1291233 1732887 Anti-Roll Bar Bush, Front F75, F85, F95, 75CF, 85CF, 95XF, CF75, CF75IV, CF85, CF85IV, XF95, XF105</p>	
<p>570047 1288000 1732886 Anti-Roll Bar Bush, Front 65CF, 75CF, 85CF, CF65, CF75, CF85, XF95</p>	
<p>570039 1400147 Anti-Roll Bar Bush, Front LF55</p>	



Anti-Roll Bar Bushes, Rear

<p>570040 1402590 Anti-Roll Bar Bottom Bush, Rear LF55</p>	
<p>570056 1402587 Anti-Roll Bar Top Bush, Rear LF55</p>	



Shock Absorbers

<p>507203 1283732 Shock Absorber, Rear F75, F85, F95, 75CF, 85CF, 95XF, CF75, CF85, CF85IV, XF95, XF105 Eye>Eye</p>	
<p>570029 1606742 1443696 1443695 1369711 1450885 Shock Absorber, Drive Axle 65CF, 75CF, 85CF, CF65, CF75, CF75IV, CF85, CF85IV, XF95, XF105 Eye>Eye</p>	
<p>570049 1401805 1407069 Shock Absorber, Front LF45, LF45IV Pin>Pin</p>	
<p>570050 1407073 Shock Absorber, Rear LF45, CF/XF RANGE Pin>Pin</p>	

Direct Sourcing Solutions

DAF Catalogue 5.14.1



This Page Is Intentionally Left Blank

Suffix Key; OE = Original Equipment, R = Reconditioned Part
OEM = Original Equipment Manufacturer, ALT = Alternative Supplier Part

OE Numbers used for Cross Reference Purposes Only

sales@direct-sourcing-solutions.com www.direct-sourcing-solutions.com

Tel; +44 (0) 1653 668179 Fax; +44 (0) 1905 507755

Direct Sourcing Solutions

DAF Catalogue 5.14.1

13: Steering Index



Adjusting Sleeves	Pg: 13
Draglinks	Pg: 6-9
Power Steering Pipe Work And Miscellaneous Parts	Pg: 5
Steering Boxes And Kits	Pg: 2-3
Steering Columns And Associated Parts	Pg: 1
Steering Pumps And O-Rings	Pg: 4
Track Rod Ball Joints	Pg: 11-12
Track Rods	Pg: 10

Suffix Key; OE = Original Equipment, R = Reconditioned Part
OEM = Original Equipment Manufacturer, ALT = Alternative Supplier Part

OE Numbers used for Cross Reference Purposes Only

sales@direct-sourcing-solutions.com www.direct-sourcing-solutions.com

Tel; +44 (0) 1653 668179 Fax; +44 (0) 1905 507755



Steering Columns And Associated Parts

<p>550030R 1398859 1654387 1792627 Steering Shaft CF75, CF85</p>	



Steering Boxes And Kits

550026

1444713

Power Steering Box

CF65, CF75, CF75IV, CF85, CF85IV



550028

1444715

Power Steering Box, Twin Steer

CF65, CF75, CF75IV, CF85, CF85IV



550019

1343211 1363863 1444789

Power Steering Box, Twin Steer Tractor Unit

95XF, XF95, XF105



550027

1444787

Power Steering Box, Single Steer Tractor Unit

95XF, XF95, XF105



550021

1444800

Power Steering Box, Twin Steer Rigid

XF95, XF105



Suffix Key; OE = Original Equipment, R = Reconditioned Part

OEM = Original Equipment Manufacturer, ALT = Alternative Supplier Part

OE Numbers used for Cross Reference Purposes Only



sales@direct-sourcing-solutions.com www.direct-sourcing-solutions.com

Tel; +44 (0) 1653 668179 Fax; +44 (0) 1905 507755

Section: 13, Pg: 2



Steering Boxes And Kits

<p>550023 1301253 1612172 1697520 Power Steering Box, Angle Drive 85CF, CF85</p>	
<p>550043 1612046 Steering Box Repair Kit F65, F75, F85, F95, 65CF, 75CF, 85CF, 95XF, CF65, CF75, CF75IV, CF85, CF85IV, XF95, XF105</p>	



Steering Pumps And O-Rings

550011OEM

1375507

Power Steering Pump

F75, F85, F95, 75CF, 85CF, 95XF, CF75, CF75IV, CF85, CF85IV, XF95, BUS



550025OEM

1291228

Power Steering Pump

85CF, 95XF



550006OEM

1401813

Power Steering Pump

LF45



550040

1695495 1797650

Power Steering Pump

CF85IV, XF95, XF105



550042OEM

1797652

Power Steering Pump

CF85IV, XF95, XF105



Suffix Key; OE = Original Equipment, R = Reconditioned Part

OEM = Original Equipment Manufacturer, ALT = Alternative Supplier Part

OE Numbers used for Cross Reference Purposes Only

sales@direct-sourcing-solutions.com www.direct-sourcing-solutions.com

Tel; +44 (0) 1653 668179 Fax; +44 (0) 1905 507755

Section: 13, Pg: 4







Power Steering Pipe Work And Miscellaneous Parts

<p>507600 393890 Steering Universal Joint 100mm F2800, F2900, F3200, F3300, F3600, N2800, F65, F75, F95, 65CF, 75CF, 85CF, 95XF, CF65, CF75, CF85, CF85IV, XF95, XF105</p>	



Draglinks

<p>507611 1385497 1351714 1283211 Draglink Assembly, Length 876mm F75, 65CF, 75CF, 85CF Use Ball Joint 507609</p>	
<p>507612 1385492 1283212 1247597 1351715 Draglink Assembly, Length 848mm F75, 65CF, 75CF, 85CF Use Ball Joint 507609</p>	
<p>550014 1451122 Draglink Assembly, Length 1977mm F85, CF75, CF85</p>	
<p>550033 1380417 1451129 Draglink Assembly, Length 860mm F85, CF75, CF85</p>	
<p>550007 1291060 1351734 1385499 Draglink Assembly, Length 1005mm F95, 95XF, XF95 Use Ball Joint 507609</p>	

Suffix Key; OE = Original Equipment, R = Reconditioned Part
 OEM = Original Equipment Manufacturer, ALT = Alternative Supplier Part

OE Numbers used for Cross Reference Purposes Only

sales@direct-sourcing-solutions.com www.direct-sourcing-solutions.com

Tel; +44 (0) 1653 668179 Fax; +44 (0) 1905 507755

Section: 13, Pg: 6



Draglinks

550005

1602821 1448063 1363859

Draglink, Length 867mm

65CF, 75CF, 85CF, CF75, CF75IV, CF85, CF85IV



550031

1405655 1406025 1407144 1700912

Draglink Assembly, Length 889.5mm

LF45



550032

1405309

Draglink Assembly, Length 926mm

LF55, CF65



550041

1405363

Draglink Assembly, Length 909mm

LF55, LF55IV



550035

1451121

Draglink Assembly, Double Crank, Length 1815mm

CF75, CF85



Suffix Key; OE = Original Equipment, R = Reconditioned Part
OEM = Original Equipment Manufacturer, ALT = Alternative Supplier Part

OE Numbers used for Cross Reference Purposes Only

sales@direct-sourcing-solutions.com www.direct-sourcing-solutions.com

Tel; +44 (0) 1653 668179 Fax; +44 (0) 1905 507755

Section: 13, Pg: 7



Draglinks

<p>550036 1451123 Draglink Assembly, Length 1015mm CF75, CF85</p>	
<p>550034 1451119 Draglink Assembly, Length 590mm CF75, CF85, XF95, XF105</p>	
<p>550022 1451118 Draglink, Twin Steer, Steering Relay > 2nd Axle, Length 860mm CF75, CF75IV, CF85, CF85IV, XF95, XF105</p>	
<p>550008 Alternatives; 550008OEM 1395994 Draglink, Length 991mm XF95, XF105</p>	
<p>550004 1395995 Draglink, Length 1000mm XF95, XF105</p>	



Direct Sourcing Solutions

DAF Catalogue 5.14.1

Section 13: Steering







Draglinks

<p>550038 1395993 Draglink Assembly, Length 996mm XF95, XF105</p>	
<p>550037 1396000 Draglink Assembly, Length 1952mm XF95, XF105</p>	



Track Rods

<p>550010 1353391 1270853 Track Rod, Length 1698mm F65, F75, F85, F95, 65CF, 75CF, 85CF, 95XF, LF55, LF55IV, CF65, CF65II, CF65IV, CF75, CF75IV, CF85, CF85IV, XF95, XF105</p>	
<p>550017 1270854 1337644 288281 Track Rod, Length 1734mm F85, 85CF, 95XF, LF55, CF65, CF75, CF85, XF95, XF105</p>	
<p>550009 1361155 1297572 Track Rod, Length 1522mm 75CF, 85CF, 95XF, CF75, CF75IV, CF85, CF85IV, XF95, XF105</p>	
<p>550013 1385493 1351718 1257991 Track Rod, Length 860mm LF55, CF65, CF75, CF85, XF95, XF105</p>	



Track Rod Ball Joints

<p>507601 1331925 1326896 1229944 698609 694360 694298</p> <p>Track Rod Ball Joint RHT</p> <p>F800, F1000, F1100, F1300, F1600, F1700, F1800, F1900, F2100, F2300, F2500, F2700, F2800, F2900, F3200, F3300, F3600, N2800, F65, F75, F95, 65CF, 75CF, 85CF, CF65, CF75, CF75IV, CF85, CF85IV, XF95, XF105, BUS</p>	
<p>507613 1338714 1319838 1315447 607998 311300</p> <p>Track Rod Ball Joint LHT</p> <p>F800, F1000, F1100, F1300, F1600, F1700, F1800, F1900, F2100, F2300, F2500, F2700, F65, F75, F85, F95, 65CF, 75CF, 85CF, 95XF, CF65, CF65II, CF75, CF75IV, XF95, XF105, BUS</p>	
<p>507606 67389</p> <p>Track Rod End RHT</p> <p>F65, F75, F85, F95, 75CF, 85CF</p>	
<p>507607 67303</p> <p>Track Rod End LHT</p> <p>F65, F75, F85, F95, 75CF, 85CF</p>	
<p>507619 1703473 1604248</p> <p>Track Rod End RHT</p> <p>LF45</p>	



Track Rod Ball Joints

<p>507618 1703472 1604247 Track Rod End LHT LF45</p>	



Adjusting Sleeves

107436

1394801

Track Rod Adjusting Sleeve

F65, F75, F85, F95, 65CF, 75CF, 85CF, 95XF, CF75, CF75IV, CF85, CF85IV, XF95, XF105



Suffix Key; OE = Original Equipment, R = Reconditioned Part

OEM = Original Equipment Manufacturer, ALT = Alternative Supplier Part

OE Numbers used for Cross Reference Purposes Only

sales@direct-sourcing-solutions.com www.direct-sourcing-solutions.com

Tel; +44 (0) 1653 668179 Fax; +44 (0) 1905 507755

Section: 13, Pg: 13

Direct Sourcing Solutions

DAF Catalogue 5.14.1

14: Brakes Index



ABS Sensors And Associated Parts	Pg: 18	Relay And Quick Release Valves	Pg: 6
Air Dryer Filters, Desiccant And Repair Kits	Pg: 3	Switches And Sensors	Pg: 19
Air Dryers, Wabco/Knorr	Pg: 2	Trailer Control Valves	Pg: 7
Automatic Slack Adjusters	Pg: 17	Valves And Silencers, Miscellaneous	Pg: 9
Brake Calipers And Repair Kits	Pg: 13-14		
Brake Chambers	Pg: 10		
Brake Discs	Pg: 15		
Brake Drums	Pg: 12		
Brake Dust Covers	Pg: 16		
Brake Shoe Return Springs And Pins	Pg: 11		
Compressors And Repair Kits	Pg: 1		
EBS Valves And Kits	Pg: 8		
Foot Brake Control Valves And Repair Kits	Pg: 5		
Multi Circuit, Air Supply Valves And Distribution Manifolds	Pg: 4		

Suffix Key; OE = Original Equipment, R = Reconditioned Part
OEM = Original Equipment Manufacturer, ALT = Alternative Supplier Part

OE Numbers used for Cross Reference Purposes Only

sales@direct-sourcing-solutions.com www.direct-sourcing-solutions.com

Tel; +44 (0) 1653 668179 Fax; +44 (0) 1905 507755





Compressors And Repair Kits

<p>560011OEM 1310523 1451651 1786678 1736785 1628444 1621322 Compressor Wabco F75, F95, 75CF, 85CF, 95XF, CF75, CF85, XF95</p>	



Air Dryers, Wabco/Knorr

<p>560013 1443153 1374293 Air Dryer Knorr 95XF, CF65, CF75, CF75IV, CF85, CF85IV, XF95, XF105</p>	
---	---

<p>560032OEM 1607424 Air Dryer 95XF, CF65, CF75, CF75IV, CF85, CF85IV, XF95, XF105</p>	
--	---

--	--

--	--

--	--



Multi Circuit, Air Supply Valves And Distribution Manifolds

560014

1612054 1607416

Multi Circuit Protection Valve

65CF, 75CF, 85CF, CF65, CF75, CF75IV, CF85, CF85IV, XF95, XF105



Suffix Key; OE = Original Equipment, R = Reconditioned Part

OEM = Original Equipment Manufacturer, ALT = Alternative Supplier Part

OE Numbers used for Cross Reference Purposes Only

sales@direct-sourcing-solutions.com www.direct-sourcing-solutions.com

Tel; +44 (0) 1653 668179 Fax; +44 (0) 1905 507755

Section: 14, Pg: 4





Foot Brake Control Valves And Repair Kits

<p>560027OEM 1455027 Foot Valve CF75, CF75IV, CF85, CF85IV, XF95, XF105</p>	



Relay And Quick Release Valves

<p>560021OEM 1315693 Relay Redundancy Valve 95XF</p>	
--	---

<p>560022OEM 1448019 Relay Valve On Front Axle 75CF, 85CF, CF75, CF75IV, CF85, CF85IV, XF95, XF105</p>	
--	---

--	--

--	--

--	--



Direct Sourcing Solutions

DAF Catalogue 5.14.1

Section 14: Brakes



Trailer Control Valves

<p>560020OEM 1601034 Trailer Control Valve 75CF, 85CF</p>	
<p>506006 830550 Trailer Control Valve</p>	

Suffix Key; OE = Original Equipment, R = Reconditioned Part
OEM = Original Equipment Manufacturer, ALT = Alternative Supplier Part

OE Numbers used for Cross Reference Purposes Only

sales@direct-sourcing-solutions.com www.direct-sourcing-solutions.com

Tel; +44 (0) 1653 668179 Fax; +44 (0) 1905 507755

Section: 14, Pg: 7





EBS Valves And Kits

<p>560024OEM 1305452 EBS Modulator Valve Drive Axle 2 Channel F75, F85, F95, 75CF, 85CF, 95XF, LF55, CF75, CF75IV, CF85, CF85IV, XF95, XF105</p>	



Valves And Silencers, Miscellaneous

<p>560026OEM 1274469 Brake Relay Valve F75, F85, F95, 75CF, 85CF, 95XF, CF75, CF75IV, CF85, CF85IV, XF95, XF105</p>	
---	---

<p>560023OEM 1607919 Modulator Valve Rear Axle 85CF, CF75, CF75IV, CF85, CF85IV, XF95, XF105 For EBS Suspension</p>	
---	---

--	--

--	--

--	--



Brake Chambers

<p>560017 Alternatives; 560017OEM 1373676 Brake Chamber Front Type 14 Disc CF75, CF75IV, CF85, CF85IV, XF95, XF105</p>	
<p>560016OEM 1373682 Brake Chamber Front Type 24 Disc 75CF, 85CF, CF75, CF75IV, CF85, CF85IV, XF95, XF105</p>	
<p>560015OEM 1373681 Brake Chamber Front Type 24 Disc CF75IV, CF85IV, XF105</p>	
<p>560018OEM Alternatives; 560018 1686001 1360929 Brake Chamber L/H Rear, Type 24/24 Disc 65CF, 75CF, 85CF, CF65, CF75, CF75IV, CF85, CF85IV, XF95, XF105</p>	
<p>560019OEM Alternatives; 560019 1686002 1365122 Brake Chamber R/H Rear, Type 24/24 Disc 65CF, 75CF, 85CF, CF65, CF75, CF75IV, CF85, CF85IV, XF95, XF105</p>	

Suffix Key; OE = Original Equipment, R = Reconditioned Part
OEM = Original Equipment Manufacturer, ALT = Alternative Supplier Part

OE Numbers used for Cross Reference Purposes Only

sales@direct-sourcing-solutions.com www.direct-sourcing-solutions.com

Tel; +44 (0) 1653 668179 Fax; +44 (0) 1905 507755

Section: 14, Pg: 10



Brake Shoe Return Springs And Pins

<p>560029 96242 290377 Brake Shoe Pin F65, F75, F85, F95, 65CF, 75CF, 85CF, 95XF, CF65, CF75, CF75IV, CF85, CF85II, CF85IV, XF95, XF105</p>	

Direct Sourcing Solutions

DAF Catalogue 5.14.1

Section 14: Brakes



Brake Drums

560031

90498 275824 1232806

Brake Drum 7"

F75, F85, F95, 75CF, 85CF, 95XF

Front And Rear



Suffix Key; OE = Original Equipment, R = Reconditioned Part

OEM = Original Equipment Manufacturer, ALT = Alternative Supplier Part

OE Numbers used for Cross Reference Purposes Only

sales@direct-sourcing-solutions.com www.direct-sourcing-solutions.com

Tel; +44 (0) 1653 668179 Fax; +44 (0) 1905 507755

Section: 14, Pg: 12



Brake Calipers And Repair Kits

<p>560009 1658011R Brake Caliper L/H 75CF, 85CF, LF55, CF65, CF65IIL, CF65IV, CF75, CF75IV, CF85, CF85IV, XF95, XF105</p>	
<p>560010 1658010R Brake Caliper R/H 75CF, 85CF, LF55, CF65, CF65IIL, CF65IV, CF75, CF75IV, CF85, CF85IV, XF95, XF105</p>	
<p>560033 1203033 Brake Caliper L/H Piston 56mm LF45</p>	
<p>560034 1203032 Brake Caliper R/H Piston 56mm LF45</p>	
<p>560003 1689313 1622785 1616894 Brake Caliper Repair Kit 75CF, 85CF, LF55, CF65, CF65IIL, CF75, CF75IV, CF85, CF85IV, XF95, XF105</p>	



Brake Calipers And Repair Kits

<p>560030 1639100 Brake Caliper Slide Repair Kit 75CF, 85CF, LF55, CF65, CF65II, CF65IV, CF75, CF75IV, CF85, CF85IV, XF95, XF105</p>	

Direct Sourcing Solutions

DAF Catalogue 5.14.1

Section 14: Brakes



Brake Discs

<p>560001 1726138 1640561 1387439 1739542 Brake Disc 65CF, 75CF, 85CF, 95XF, LF55, LF55IV, CF65, CF65II, CF65IV, CF75, CF75IV, CF85, CF85IV, XF95, XF105</p>	



Brake Dust Covers

<p>560012 1231433 1231434 Brake Dust Cover Set F65, F75, F85, F95, 65CF, 75CF, 85CF, 95XF, CF75, CF85, XF95</p>	



Automatic Slack Adjusters

<p>506058 1263485 Automatic Slack Adjuster L/H F75, F85, 75CF, 85CF, CF75, CF75IV, CF85, CF85IV</p>	
<p>506059 1263486 Automatic Slack Adjuster R/H F75, F85, 75CF, 85CF, CF75, CF75IV, CF85, CF85IV</p>	

Suffix Key; OE = Original Equipment, R = Reconditioned Part
OEM = Original Equipment Manufacturer, ALT = Alternative Supplier Part

OE Numbers used for Cross Reference Purposes Only

sales@direct-sourcing-solutions.com www.direct-sourcing-solutions.com

Tel; +44 (0) 1653 668179 Fax; +44 (0) 1905 507755

Section: 14, Pg: 17



ABS Sensors And Associated Parts

<p>560004 1805821 1391515 ABS Exciter Ring Front Hub 65CF, 75CF, 85CF, LF55, LF55IV, CF65, CF65II, CF65IV, CF75, CF75IV, CF85, CF85IV, XF95, XF105</p>	
<p>560005 1805822 1391516 ABS Exciter Ring Front Hub CF75IV, CF85IV, XF105</p>	
<p>560006 1805823 1391517 ABS Exciter Ring Rear Hub 65CF, 75CF, 85CF, LF55, CF65, CF75, CF85, CF85IV, XF95, XF105 Radial Angle Approximately 75°</p>	
<p>560007 1805824 1657638 ABS Exciter Ring Rear Hub CF75IV, CF85IV, XF105 Radial Angle 90°</p>	
<p>560008 1778554 1361393 ABS Sensor 40cm 65CF, 75CF, 85CF, LF55IV, CF65, CF65II, CF65IV, CF75, CF75IV, CF85, CF85IV, XF95, XF105 17cm Longer Than DAF Sensor</p>	

Suffix Key; OE = Original Equipment, R = Reconditioned Part

OEM = Original Equipment Manufacturer, ALT = Alternative Supplier Part

OE Numbers used for Cross Reference Purposes Only

sales@direct-sourcing-solutions.com www.direct-sourcing-solutions.com

Tel; +44 (0) 1653 668179 Fax; +44 (0) 1905 507755

Section: 14, Pg: 18

Direct Sourcing Solutions

DAF Catalogue 5.14.1

Section 14: Brakes



Switches And Sensors

560025OEM

1450872

ECAS Pressure Sensor

95XF, LF55, LF55IV, CF75, CF85, CF85IV, XF95, XF105



Suffix Key; OE = Original Equipment, R = Reconditioned Part

OEM = Original Equipment Manufacturer, ALT = Alternative Supplier Part

OE Numbers used for Cross Reference Purposes Only

sales@direct-sourcing-solutions.com www.direct-sourcing-solutions.com

Tel; +44 (0) 1653 668179 Fax; +44 (0) 1905 507755

Section: 14, Pg: 19



Body Panels, Doors & Ancillary Parts:		Heater Equipment	Pg: 41
LF45	Pg: 1-2	Mirrors	Pg: 27-34
LF55	Pg: 3-4	Seats, Fittings And Associated Parts	Pg: 45-47
CF65/75/85	Pg: 5-8	Window Regulators	Pg: 44
95XF 1997 > 2002	Pg: 9-14	Wings, Rear	Pg: 25-26
XF95 2ND SERIES 2002 > 2006	Pg: 15-20	Wipers, Washers And Associated Parts	Pg: 43
XF105	Pg: 21-24		
Air Conditioning Radiators And Associated Parts	Pg: 42		
Cab Filters	Pg: 40		
Cab Jack Pumps	Pg: 38		
Cab Jack Rams	Pg: 39		
Cab Level Valves And Link Rods	Pg: 37		
Cab Mountings	Pg: 35		
Cab Shock Absorbers And Associated Parts	Pg: 36		



Section 15: Cab & Body Continued Overleaf

DAF LF 45

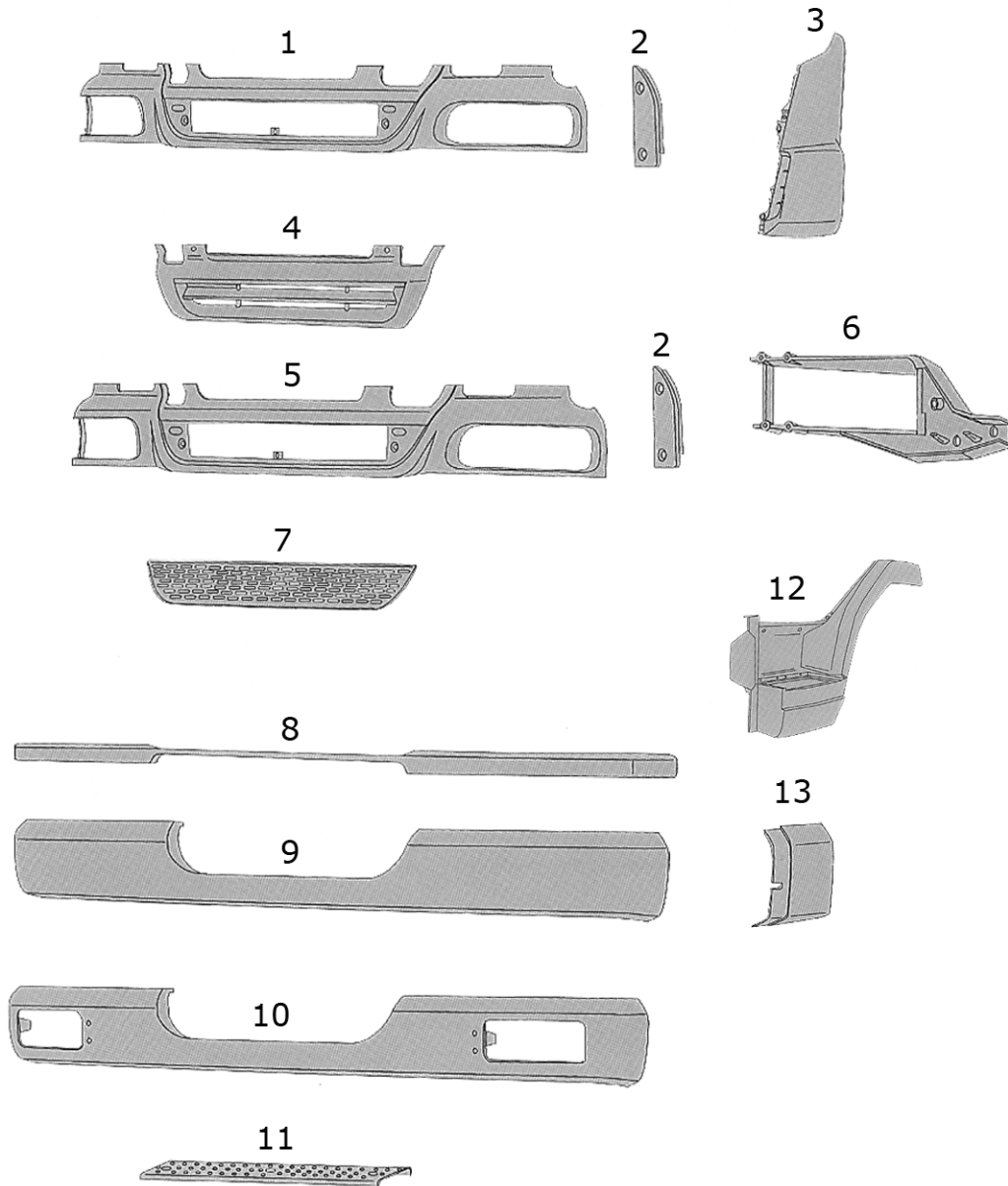



Section: 15, Pg: 2

1	509192	Bumper Mounting Bracket >2006 1701375 1700801
2	509191	Bumper End Cap L/H 1405011 1700880
2	509190	Bumper End Cap R/H 1405010 1700879
3	509189	Corner Panel L/H 1400710
3	509188	Corner Panel R/H 1400711 1405231
4	509193	Bumper Grille 2006> 1700802
5	509040	Bumper Mounting Bracket 2006 > 1405008 1400501
6	509049	Headlamp Bracket L/H 1407465 1400504
6	509048	Headlamp Bracket R/H 1407464 1400505
7	509194	Bumper Grille >2006 1400506
8	509041	Lower Front Panel 1405015
9	509109	Bumper Without Holes 1405032 1405767
10	509110	Bumper 1405766
11	509187	Bumper Footstep Tread 1405005
12	509081	Wheel Arch L/H 1405247
12	509080	Wheel Arch R/H 1405250

13	509111	Bumper End Panel L/H 1405880
13	509112	Bumper End Panel R/H 1405881 1401825 1700877 1405031

Suffix Key; OE = Original Equipment, R = Reconditioned Equipment OEM = Original Equipment Manufacturer, ALT = Alternative Supplier Part

OE Numbers used for Cross Referencing Purposes Only

sales@direct-sourcing-solutions.com www.direct-sourcing-solutions.com

Tel; +44 (0) 1653 668179 Fax; +44 (0) 1905 507755

DAF LF 55

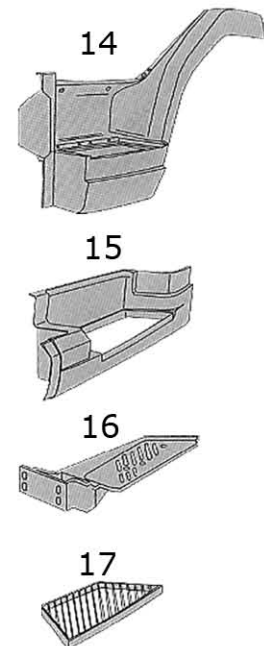
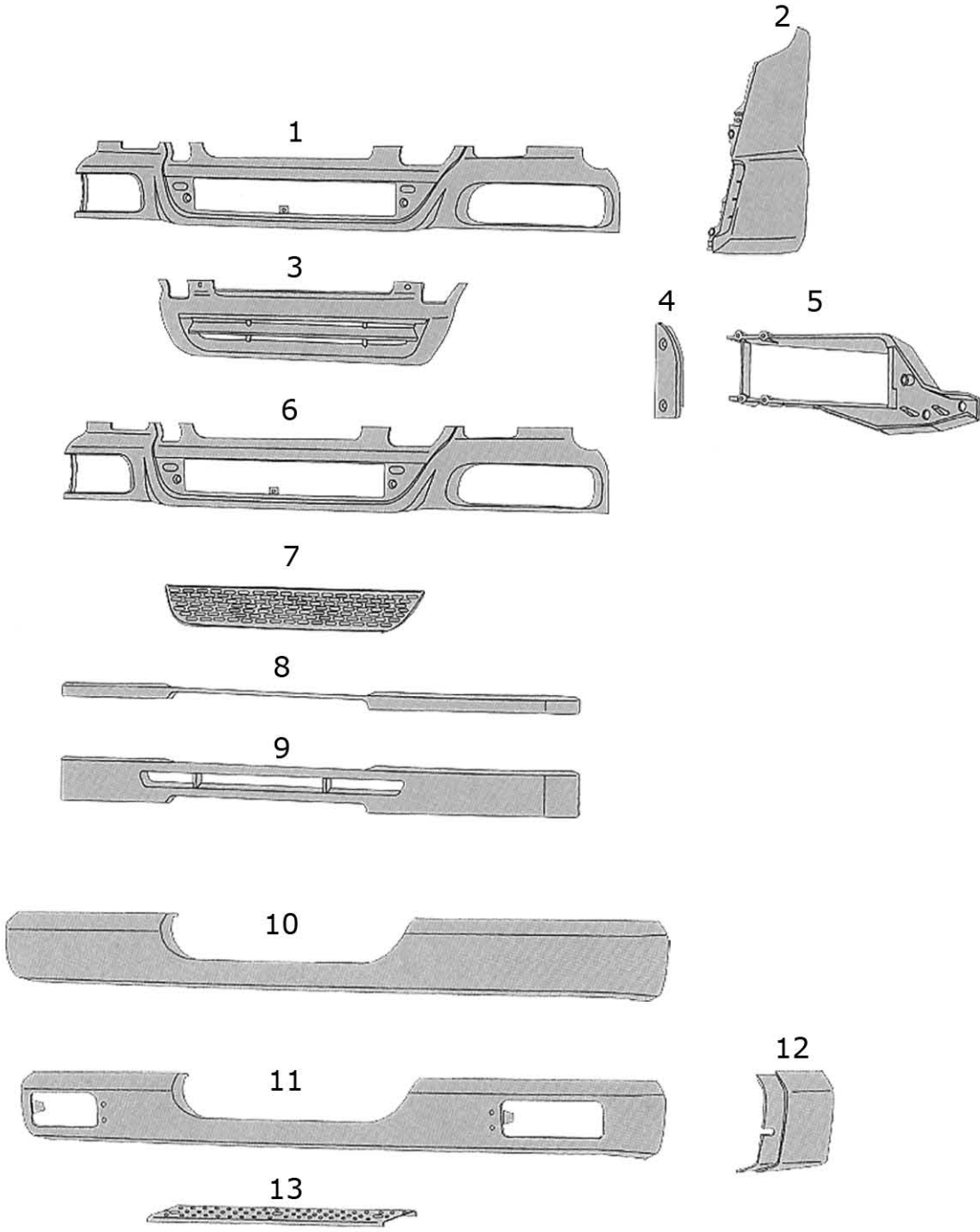
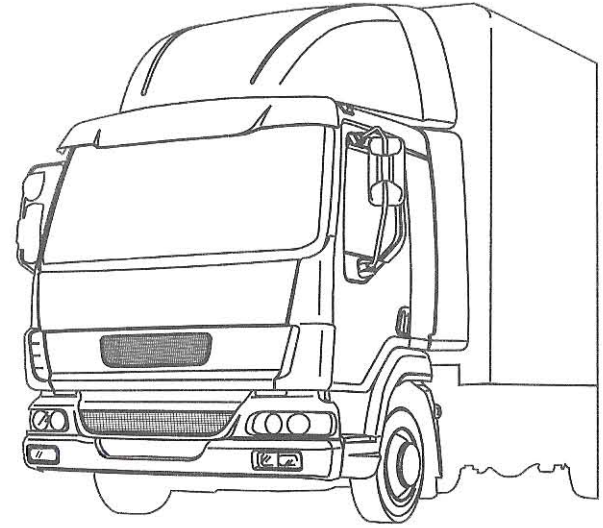



Section: 15, Pg: 4

1	509192	Bumper Mounting Bracket >2006 1701375 1700801
2	509189	Corner Panel L/H 1400710
2	509188	Corner Panel R/H 1400711 1405231
3	509193	Front Grille 1700802
4	509191	Bumper End Cap L/H 1405011 1700880
4	509190	Bumper End Cap R/H 1405010 1700879
5	509049	Headlamp Bracket L/H 1407465 1400504
5	509048	Headlamp Bracket R/H 1407464 1400505
6	509040	Bumper Mounting Bracket 2006> 1405008 1400501
7	509194	Bumper Grille 1400506
8	509041	Lower Front Panel 1405015
9	509195	Bumper Spoiler 1405013
10	509109	Bumper Without Holes 1405032 1405767
11	509110	Bumper 1405766
12	509111	Bumper End Panel L/H 1405880
12	509112	Bumper End Panel R/H 1405881 1401825 1700877 1405031

13	509187	Bumper Footstep Tread 1405005
14	509081	Wheel Arch L/H 1405247
14	509080	Wheel Arch R/H 1405250
15	509091	Footstep Panel L/H 1405990 1405243
15	509090	Footstep Panel R/H 1405991 1405244
15	509199	Footstep Panel L/H - (12-15 Tonne) 1405245 1405988
15	509198	Footstep Panel R/H - (16-18 Tonne) 1405246 1701024 1405989
16	509197	Footstep Support L/H 1405228 1407317
16	509196	Footstep Support R/H 1405227 1407316
17	509034	Lower Footstep 1405241

Suffix Key; OE = Original Equipment, R = Reconditioned Equipment OEM = Original Equipment Manufacturer, ALT = Alternative Supplier Part

OE Numbers used for Cross Referencing Purposes Only

sales@direct-sourcing-solutions.com www.direct-sourcing-solutions.com

Tel; +44 (0) 1653 668179 Fax; +44 (0) 1905 507755

DAF CF 65/75/85

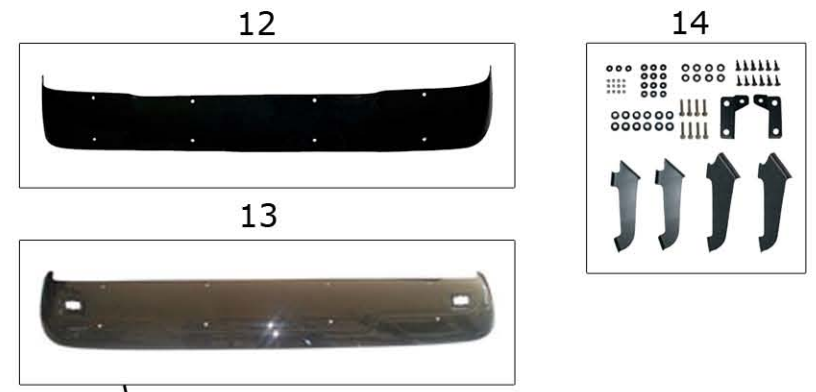
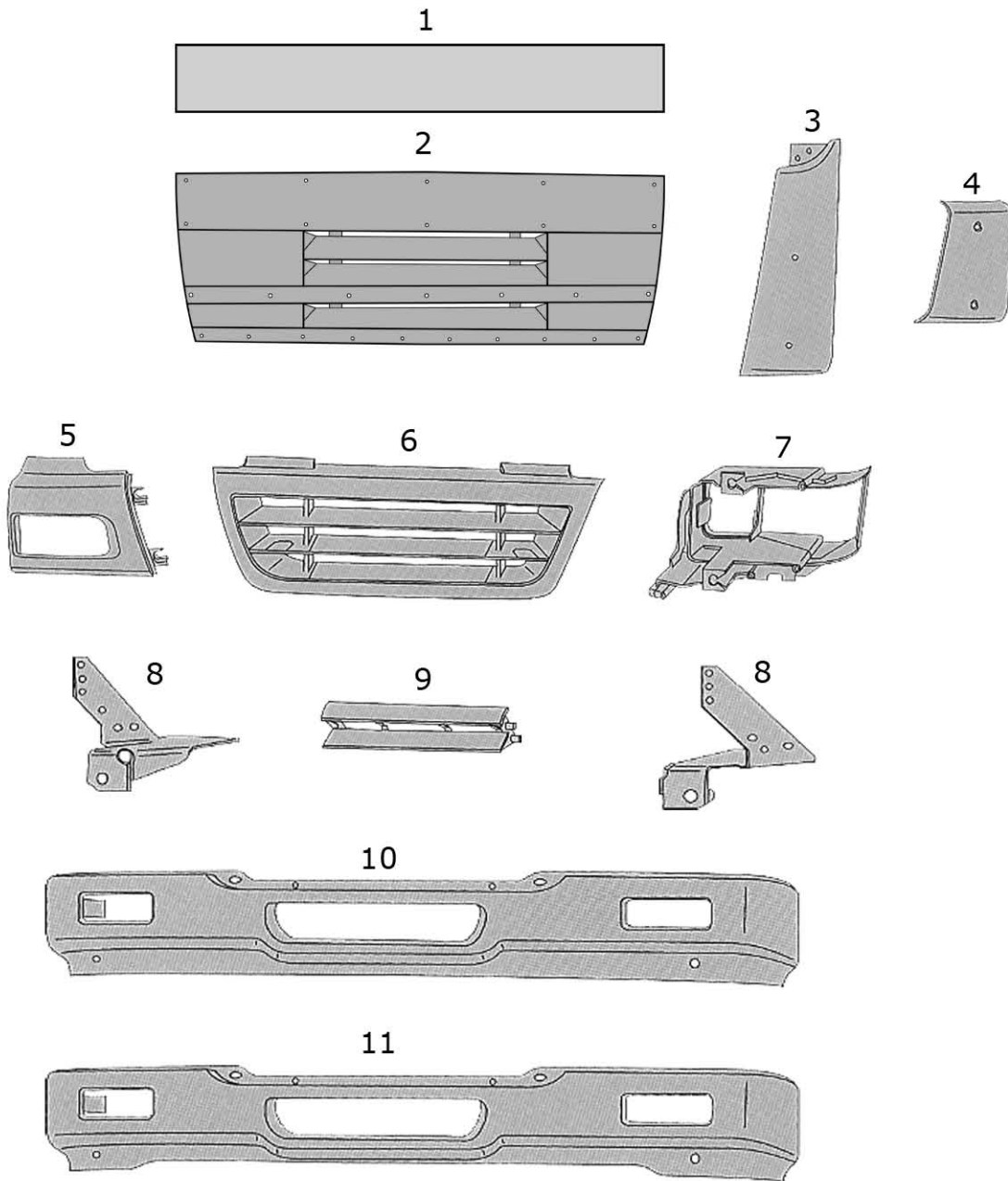



Section: 15, Pg: 6

1	509043	Upper Front Panel 1372535
2	509042	Upper Grille 1372534 1747244 1786644
3	509153	Corner Panel Inner L/H 1372532
3	509152	Corner Panel Inner R/H 1372533
4	509155	Corner Panel L/H 1362870
4	509154	Corner Panel R/H 1362871
5	590019	Headlamp Bezel L/H Grey 1435754
5	590020	Headlamp Bezel R/H Grey 1435755
5	509050	Headlamp Bezel L/H White 1363373
5	509051	Headlamp Bezel R/H White 1363374
6	509044	Lower Grille 1375876
6	590074	Lower Grille With Chrome Strip (CF85 Euro 4) 1657685
7	509052	Headlamp Bracket L/H 1372801 1385178
7	509053	Headlamp Bracket R/H 1372802 1385179
8	509172	Bumper Bracket L/H 1438576 1696660 1696662 1699468
8	509171	Bumper Bracket R/H 1438577 1696663 1699473

9	509173	Bumper Grille Insert 1363370
10	509113	Bumper (Plastic) 1363375 1656582
11	590001	Bumper (Metal) 1661269 1426274
12	590018	Sunvisor Smoked (Without Fitting Kit) * 1371875
13	590077	Sunvisor Smoked * 1312864 1312868
14	590082	Sunvisor Fitting Kit For 590018 1434334
15	590075	Door Handle L/H 1328724 1617040
15	590076	Door Handle R/H 1328725 1617041

* Check Chassis Number

Suffix Key; OE = Original Equipment, R = Reconditioned Equipment OEM = Original Equipment Manufacturer, ALT = Alternative Supplier Part

OE Numbers used for Cross Referencing Purposes Only

sales@direct-sourcing-solutions.com www.direct-sourcing-solutions.com

Tel; +44 (0) 1653 668179 Fax; +44 (0) 1905 507755

DAF CF 65/75/85

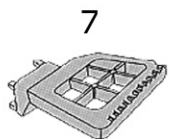
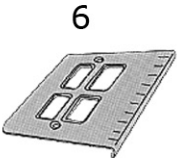
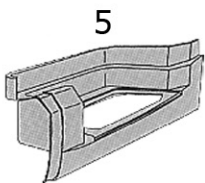
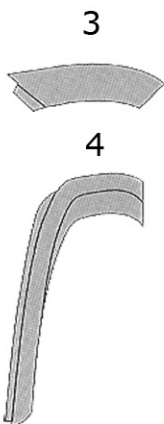
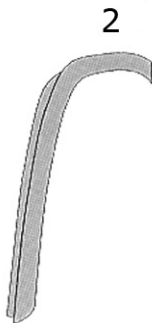
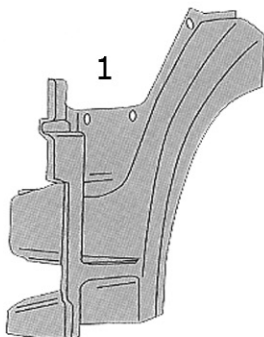



Section: 15, Pg: 8

1	509078	Wheel Arch L/H 1437809 1656917 1893901
1	509079	Wheel Arch R/H 1437810 1656918 1893902
2	509175	Mudguard Trim L/H 1298527
2	509174	Mudguard Trim R/H 1298528
3	509179	Mudguard Trim L/H 1298529 1307510
3	509178	Mudguard Trim R/H 1298530 1307511
4	509177	Mudguard Trim L/H 1296236 1324632
4	509176	Mudguard Trim R/H 1296237 1324633
5	509093	Footstep Panel L/H Grey (Construction Vehicles) 1440244
5	509092	Footstep Panel R/H Grey (Construction Vehicles) 1440245
5	509095	Footstep Panel L/H Grey 1440242
5	509094	Footstep Panel R/H Grey 1440243
5	509097	Footstep Panel L/H White 1364798 1695228
5	509096	Footstep Panel R/H White 1364799 1695229
6	509028	Footstep Tread (Aluminium) 962101

7	509027	Footstep Bracket L/H 1638480 1368836 1366253
7	509026	Footstep Bracket R/H 1638481 1368837 1366254

Suffix Key; OE = Original Equipment, R = Reconditioned Equipment OEM = Original Equipment Manufacturer, ALT = Alternative Supplier Part

OE Numbers used for Cross Referencing Purposes Only

sales@direct-sourcing-solutions.com www.direct-sourcing-solutions.com

Tel; +44 (0) 1653 668179 Fax; +44 (0) 1905 507755

DAF 95XF 1997 > 2002

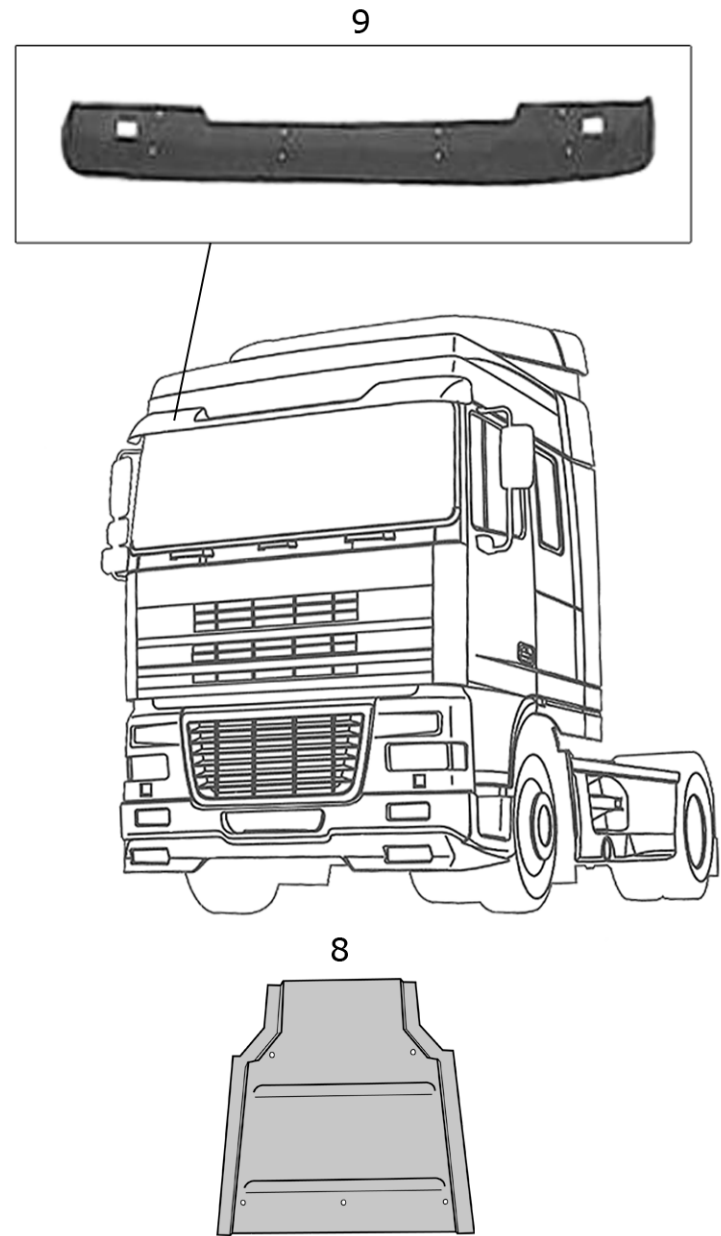
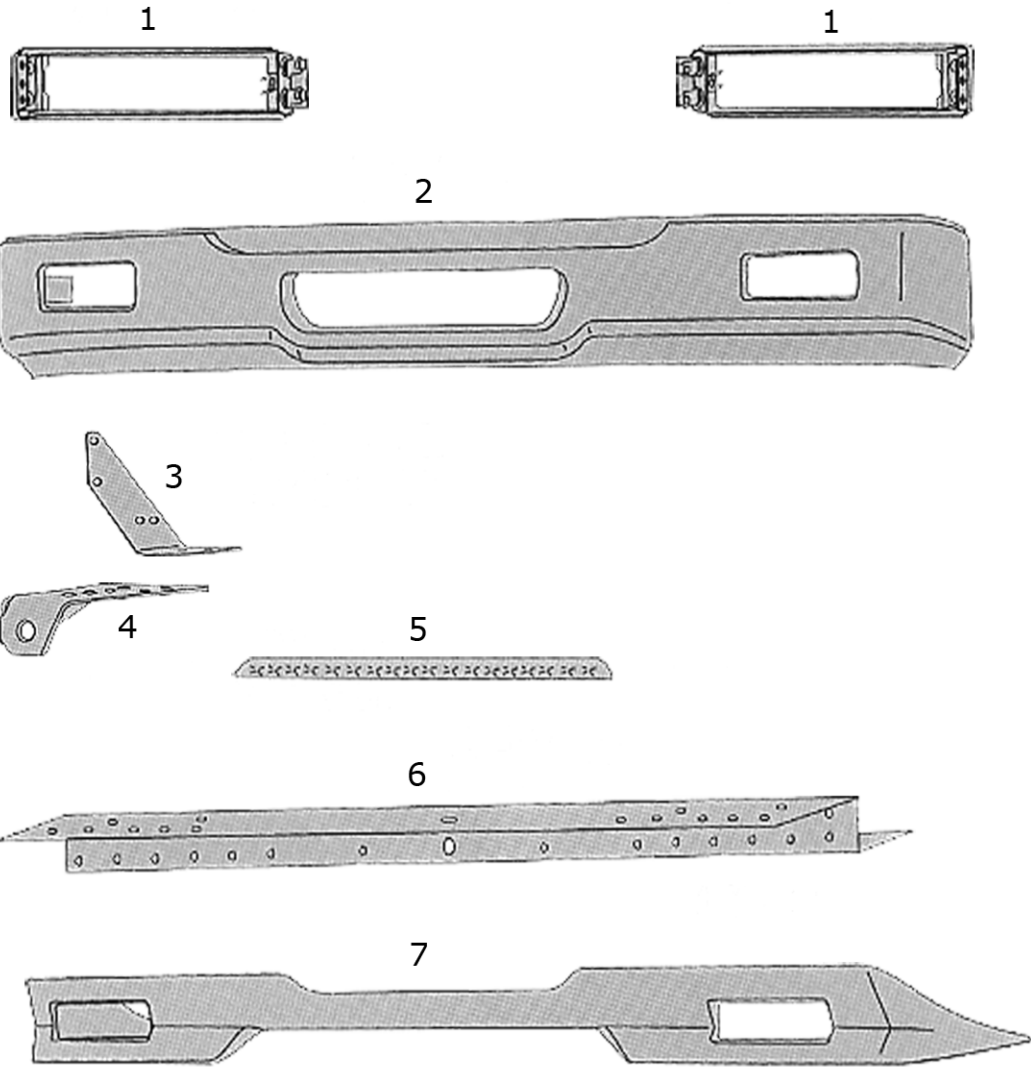



Section: 15, Pg: 10

1	509162	Fog Lamp Support Bracket L/H 1328858 1334108 1381702 1436683 1449528
1	509161	Fog Lamp Support Bracket R/H 1328859 1334109 1381703 1436684 1449529
2	509116	Bumper Bar 1290191
3	509012	Bumper Upper Bracket L/H 1319678
3	509011	Bumper Upper Bracket R/H 1319679
4	509014	Bumper Bracket L/H 1450976 1329523 1319676
4	509013	Bumper Bracket R/H 1450977
5	509105	Footstep For Bumper 948779
6	509107	Bumper Cross Member 1300041 1427140 1353802
7	509106	Spoiler 1317126
8	509140	Engine Cover (Lower) 1328945 1363278
9	590078	Sunvisor, Smoked 1308687

Suffix Key; OE = Original Equipment, R = Reconditioned Equipment OEM = Original Equipment Manufacturer, ALT = Alternative Supplier Part

OE Numbers used for Cross Referencing Purposes Only

sales@direct-sourcing-solutions.com www.direct-sourcing-solutions.com

Tel; +44 (0) 1653 668179 Fax; +44 (0) 1905 507755

DAF 95XF 1997 > 2002

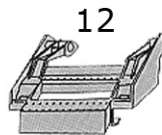
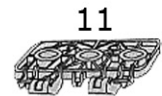
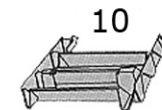
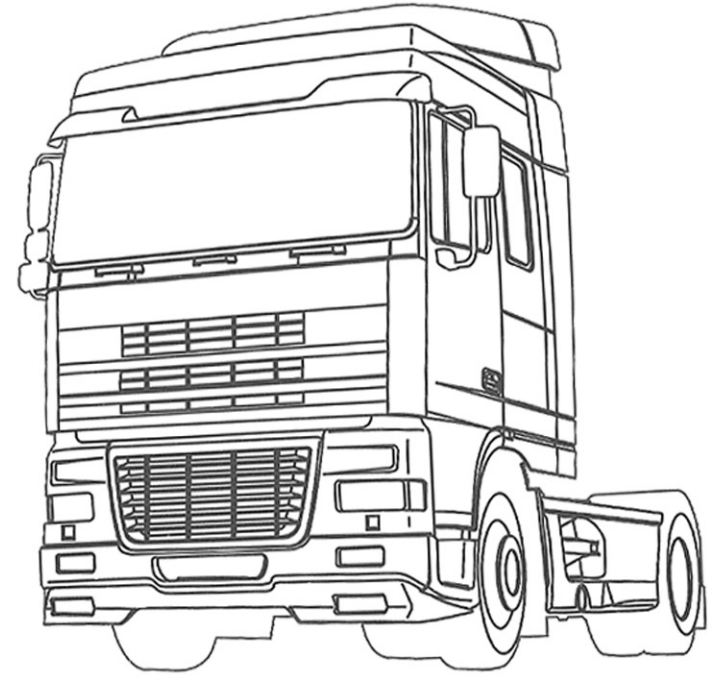
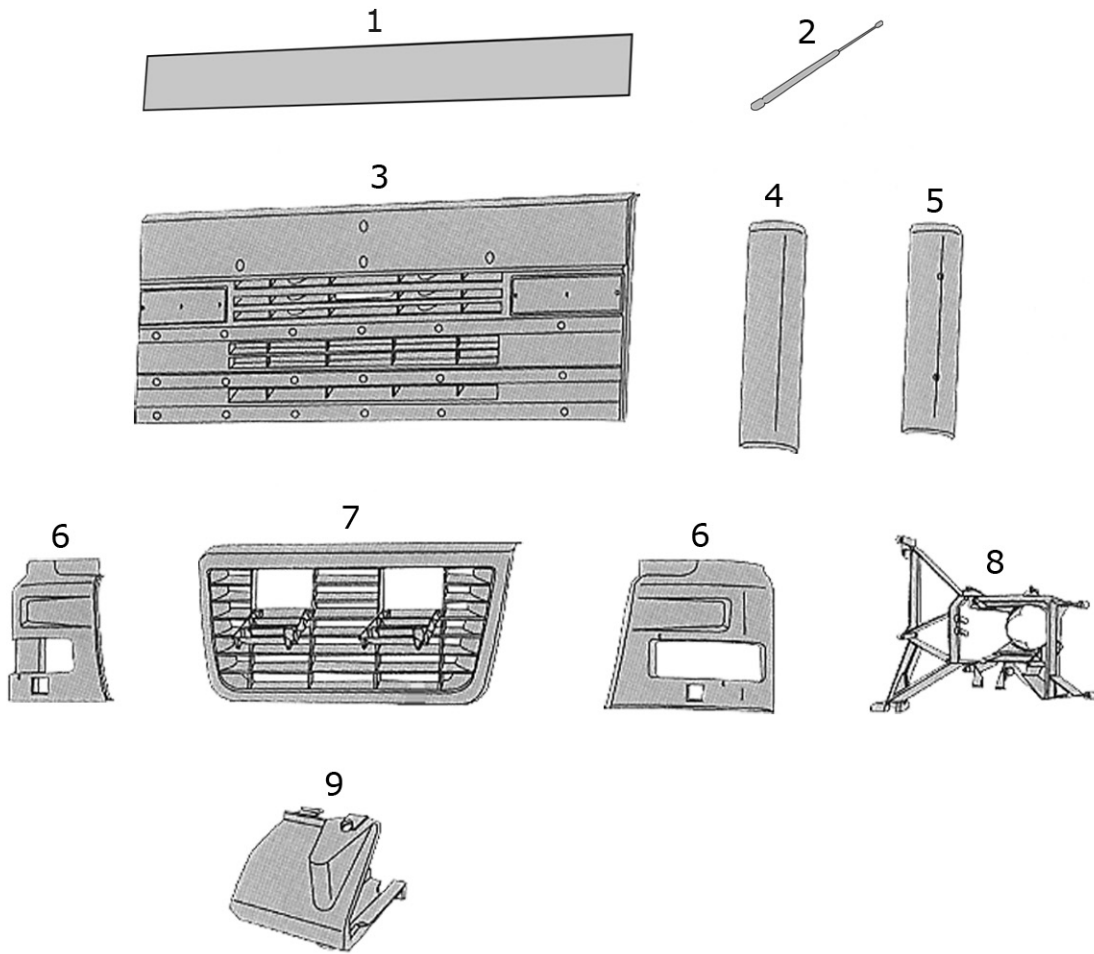



Section: 15, Pg: 12

1	509037	Upper Front Panel 1309401
2	590088	Corner Panel Gas Spring
3	509036	Upper Grille 1309400
4	509157	Corner Panel Inner L/H 1302983 280063
4	509156	Corner Panel Inner R/H 1302984 280062
5	509158	Corner Panel L/H Black 1299417
5	509159	Corner Panel R/H Black 1299418
6	509059	Headlamp Bezel L/H 1294948
6	509058	Headlamp Bezel R/H 1294949
7	509039	Lower Grille 1312789
8	509057	Lamp Bracket L/H 1308794 1295613
8	509056	Lamp Bracket R/H 1308795 1295614
9	509164	Front Grille Bracket L/H 1347131
9	509163	Front Grille Bracket R/H 1347132
10	509166	Grille Step Cover L/H 1309112
10	509165	Grille Step Cover R/H 1309113

11	509167	Grille Step Hinge L/H & R/H 1735004 1336467 1434957 1672923
12	509160	Grille Step L/H & R/H 1336468 1672838 1689404

Suffix Key; OE = Original Equipment, R = Reconditioned Equipment OEM = Original Equipment Manufacturer, ALT = Alternative Supplier Part

OE Numbers used for Cross Referencing Purposes Only

sales@direct-sourcing-solutions.com www.direct-sourcing-solutions.com

Tel; +44 (0) 1653 668179 Fax; +44 (0) 1905 507755

DAF 95XF 1997 > 2002

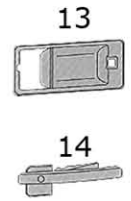
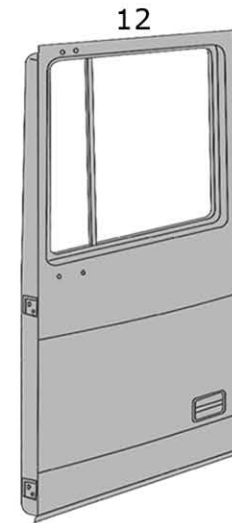
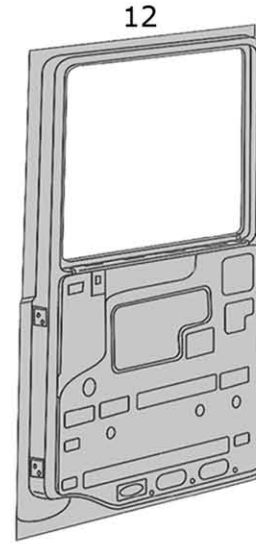
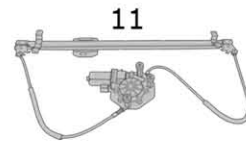
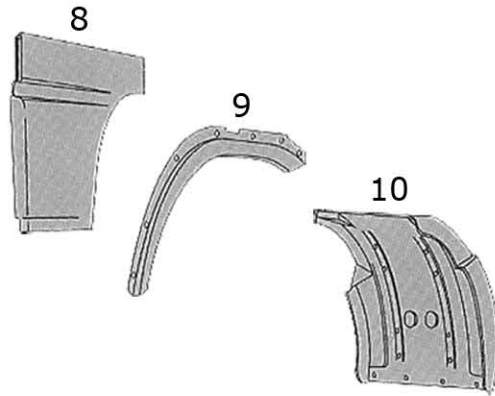
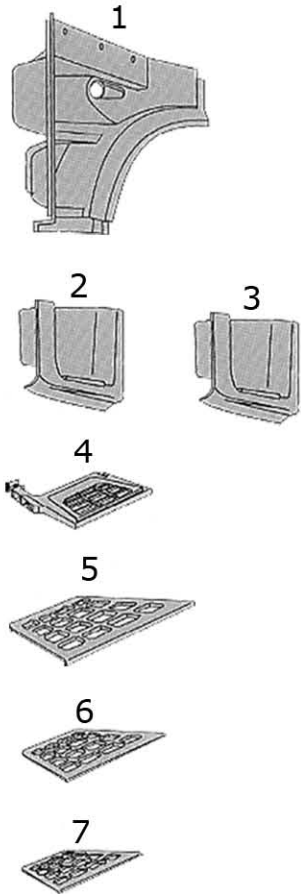



Section: 15, Pg: 14

1	509087	Footstep/Wheel Arch L/H 1291172 1656911
1	509086	Footstep/Wheel Arch R/H 1291173 1656912
2	509103	Footstep Well L/H 1295732 1695026
2	509102	Footstep Well R/H 1295735
3	509101	Footstep L/H 84096 1297699
3	509100	Footstep R/H 84097 1297700
4	509016	Footstep Bracket L/H 1347131 1303943
4	509015	Footstep Bracket R/H 1347132 1303944
5	509023	Upper Footstep Grille R/H & L/H 673144
6	509022	Centre Footstep Grille R/H & L/H 673143
7	509019	Lower Footstep Tread 962643 961229
8	509064	Door Extension L/H 1295619
8	509065	Door Extension R/H 1295620
9	590015	Mudguard Strip Front L/H 1291165
9	590016	Mudguard Strip Front R/H 1291164

10	509082	Mudguard RR Front Wheel L/H 1659253 1389296 1369437
10	509083	Mudguard RR Front Wheel R/H 1659254 1389297 1369438
11	590009	Window Regulator R/H Complete With Motor 1354703
12	590011	Door L/H 1676218 1304060
12	590010	Door R/H 1676219 1304061
13	509075	Door Handle Cover L/H 1305479
13	509074	Door Handle Cover R/H 1305480
14	509073	Door Handle L/H 1305481
14	509072	Door Handle R/H 1305482

Suffix Key; OE = Original Equipment, R = Reconditioned Equipment OEM = Original Equipment Manufacturer, ALT = Alternative Supplier Part

OE Numbers used for Cross Referencing Purposes Only

sales@direct-sourcing-solutions.com www.direct-sourcing-solutions.com

Tel; +44 (0) 1653 668179 Fax; +44 (0) 1905 507755

DAF XF 95 2ND SERIES 2002 > 2006

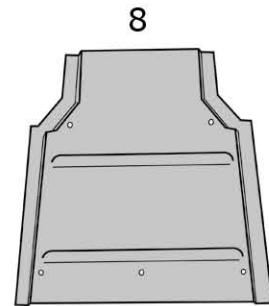
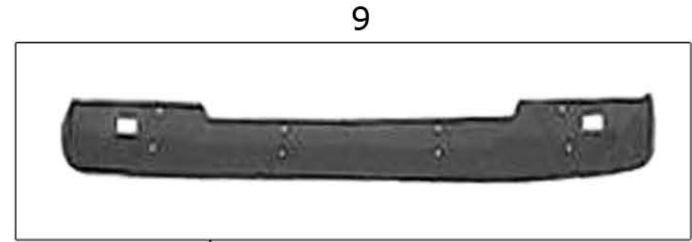
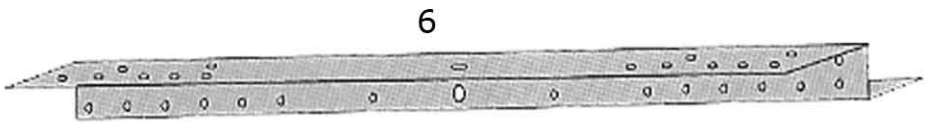
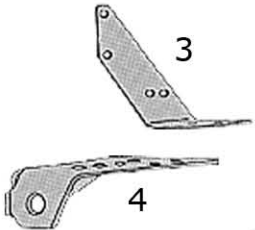
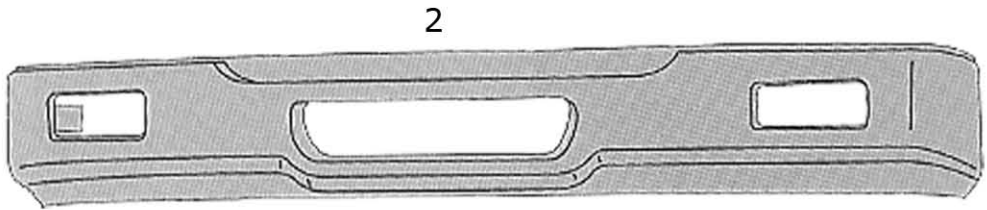



Section: 15, Pg: 16

1	509162	Fog Lamp Support Bracket L/H 1328858 1334108 1381702 1436683 1449528
1	509161	Fog Lamp Support Bracket R/H 1328859 1334109 1381703 1436684 1449529
2	509116	Front Bumper 1290191
3	509012	Bumper Bracket L/H 1319678
3	509011	Bumper Bracket R/H 1319679
4	509014	Bumper Bracket L/H 1450976 1319676 1329523
4	509013	Bumper Bracket R/H 1450977
5	509105	Footstep For Bumper 948779
6	509107	Bumper Cross Member 1427140 1300041 1353802
7	509106	Bumper Spoiler 1317126
8	509140	Engine Cover (Lower) 1328945 1363278
9	590078	Sunvisor, Smoked 1308687

Suffix Key; OE = Original Equipment, R = Reconditioned Equipment OEM = Original Equipment Manufacturer, ALT = Alternative Supplier Part

OE Numbers used for Cross Referencing Purposes Only

sales@direct-sourcing-solutions.com www.direct-sourcing-solutions.com

Tel; +44 (0) 1653 668179 Fax; +44 (0) 1905 507755

DAF XF 95 2ND SERIES 2002 > 2006

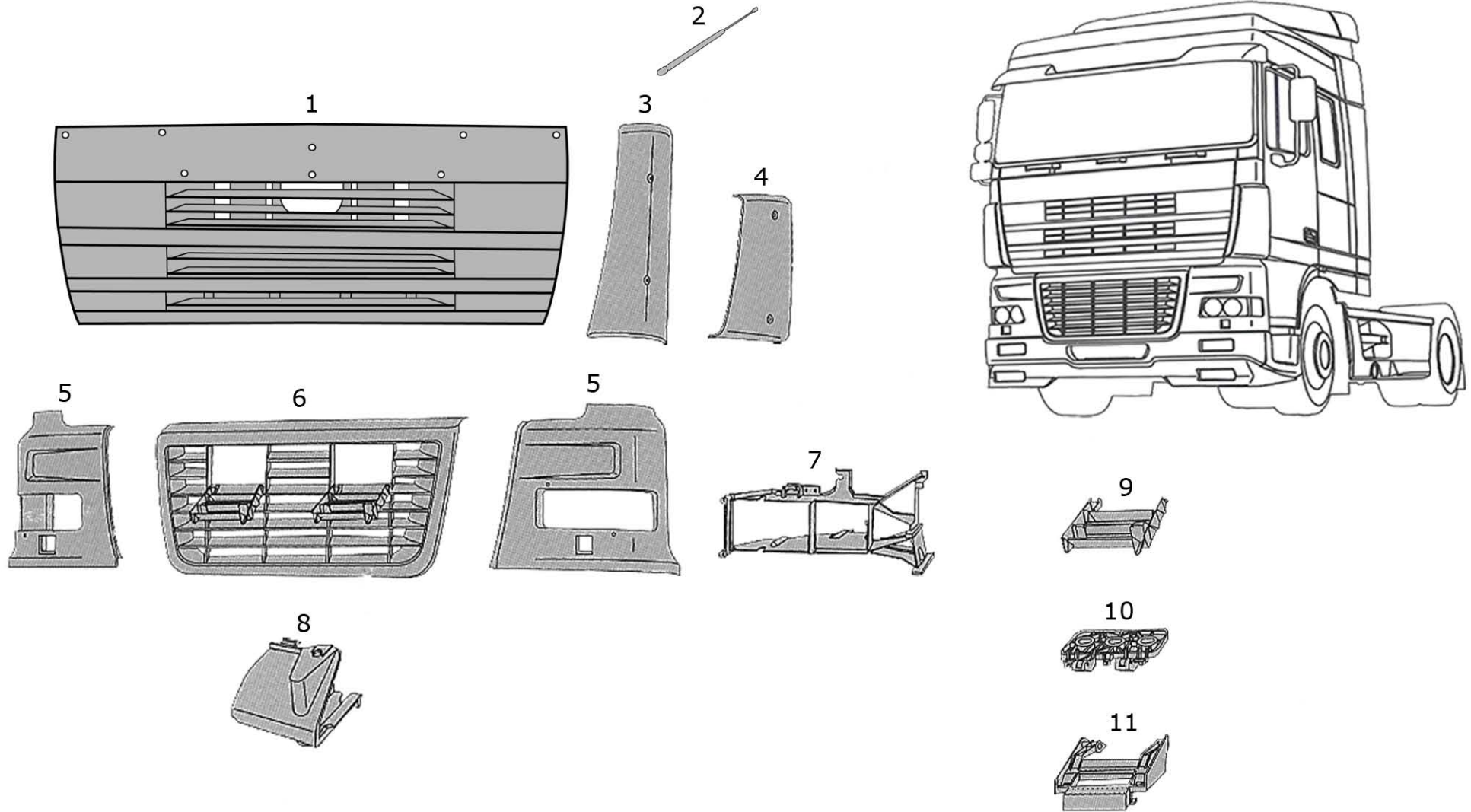



Section: 15, Pg: 18

1	509035	Upper Grille 1400004
2	590088	Corner Panel Gas Spring
3	509148	Corner Panel Inner L/H 1400011
3	509149	Corner Panel Inner R/H 1400012
4	509150	Corner Panel Outer L/H 1400013
4	509151	Corner Panel Outer R/H 1400014
5	509061	Headlamp Bezel L/H 1398284
5	509060	Headlamp Bezel R/H 1398285
6	509039	Lower Grille 1312789
7	509063	Lamp Bracket L/H 1439348 1396936
7	509062	Lamp Bracket R/H 1439349 1396937
8	509164	Lower Grille Bracket L/H 1347131
8	509163	Lower Grille Bracket R/H 1347132
9	509166	Grille Step Cover L/H 1309112
9	509165	Grille Step Cover R/H 1309113

10	509167	Grille Step Hinge L/H & R/H 1735004 1336467 1434957 1672923
11	509160	Grille Step L/H & R/H 1336468 1672838 1689404

Suffix Key; OE = Original Equipment, R = Reconditioned Equipment OEM = Original Equipment Manufacturer, ALT = Alternative Supplier Part

OE Numbers used for Cross Referencing Purposes Only

sales@direct-sourcing-solutions.com www.direct-sourcing-solutions.com

Tel; +44 (0) 1653 668179 Fax; +44 (0) 1905 507755

DAF XF 95 2ND SERIES 2002 > 2006

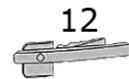
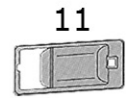
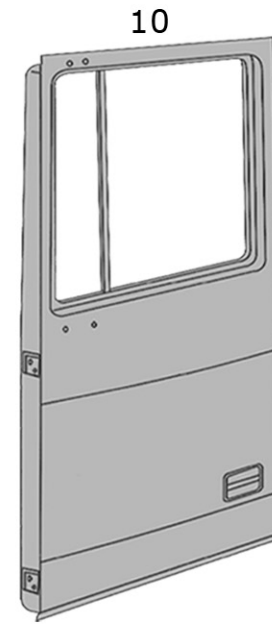
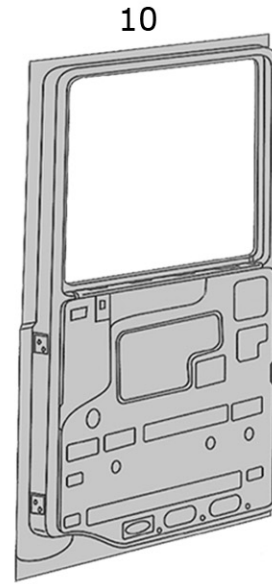
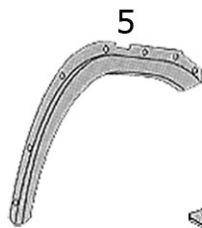
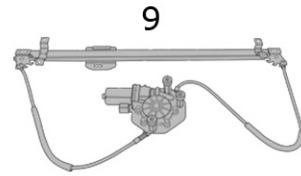
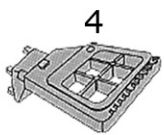
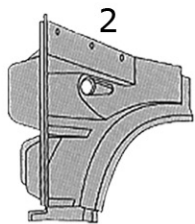
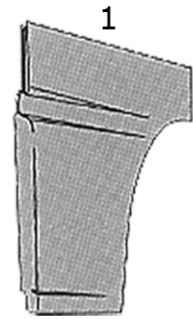



Section: 15, Pg: 20

1	509064	Door Extension L/H 1295619
1	509065	Door Extension R/H 1295620
2	509087	Footstep/Wheel Arch L/H 1291172 1656911
2	509086	Footstep/Wheel Arch R/H 1291173 1656912
3	509103	Footstep Well L/H 1295732 1695026
3	509102	Footstep Well R/H 1295735
4	509018	Footstep Bracket L/H 1605932 1445563 1447281
4	509017	Footstep Bracket R/H 1605933 1445564 1447282
5	590015	Mudguard Strip Front L/H 1291165
5	590016	Mudguard Strip Front R/H 1291164
6	509023	Upper Footstep Grille R/H & L/H 673144
7	509022	Centre Footstep Grille R/H & L/H 673143
8	509019	Lower Footstep Tread 962643 961229
9	590009	Window Regulator R/H Complete With Motor 1354703
10	590011	Door L/H 1676218 1304060
10	590010	Door R/H 1676219 1304061

11	509075	Door Handle Cover L/H 1305479
11	509074	Door Handle Cover R/H 1305480
12	509073	Door Handle L/H 1305481
12	509072	Door Handle R/H 1305482

Suffix Key; OE = Original Equipment, R = Reconditioned Equipment OEM = Original Equipment Manufacturer, ALT = Alternative Supplier Part

OE Numbers used for Cross Referencing Purposes Only

sales@direct-sourcing-solutions.com www.direct-sourcing-solutions.com

Tel; +44 (0) 1653 668179 Fax; +44 (0) 1905 507755

DAF XF 105

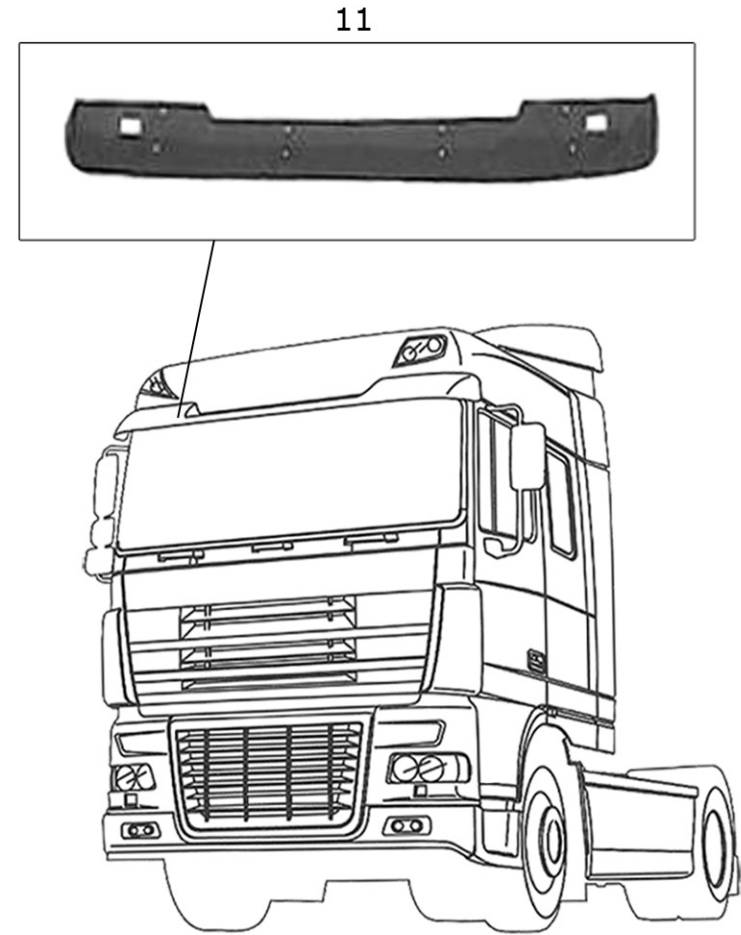
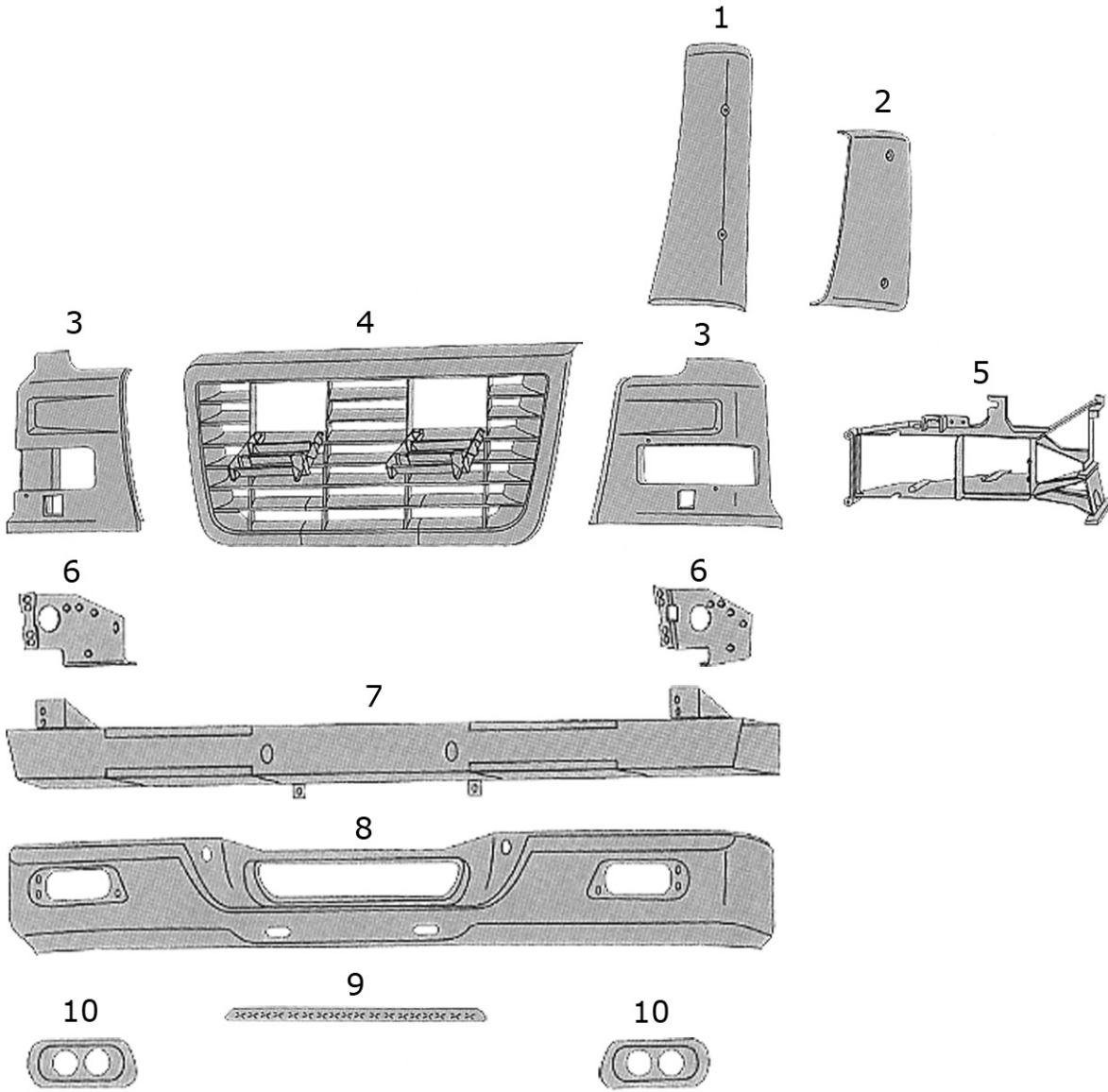



Section: 15, Pg: 22

1	509148	Corner Panel Inner L/H 1400011
1	509149	Corner Panel Inner R/H 1400012
2	509150	Corner Panel Outer Air Deflector L/H 1400013
2	509151	Corner Panel Outer Air Deflector R/H 1400014
3	509061	Headlamp Bezel L/H 1398284
3	509060	Headlamp Bezel R/H 1398285
4	509038	Lower Grille 1635802
5	509063	Lamp Bracket L/H 1439348 1396936
5	509062	Lamp Bracket R/H 1439349 1396937
6	509032	Bumper Bracket L/H 1693664 1662373 1667520
6	509033	Bumper Bracket R/H 1693665 1662374 1667521
7	509031	Bumper Cross Member 1674548
8	509104	Bumper Bar 1634640 1825008 1826225
9	509105	Footstep For Bumper 948779

10	509047	Spot Lamp Bezel L/H 1649363 1683721
10	509046	Spot Lamp Bezel R/H 1683722
11	590078	Sunvisor, Smoked 1308687

Suffix Key; OE = Original Equipment, R = Reconditioned Equipment OEM = Original Equipment Manufacturer, ALT = Alternative Supplier Part

OE Numbers used for Cross Referencing Purposes Only

sales@direct-sourcing-solutions.com www.direct-sourcing-solutions.com

Tel; +44 (0) 1653 668179 Fax; +44 (0) 1905 507755

DAF XF 105

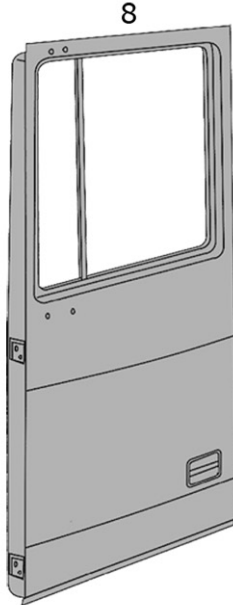
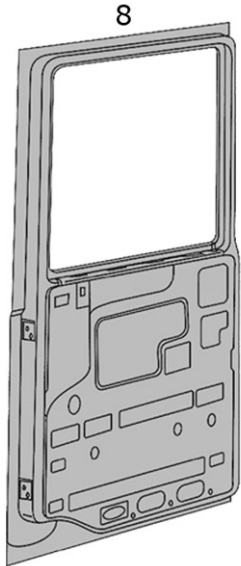
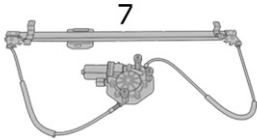
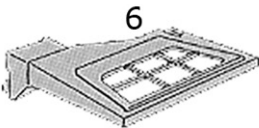
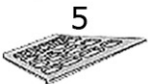
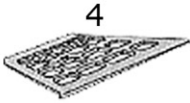
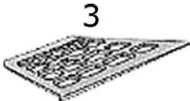
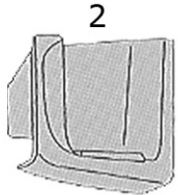
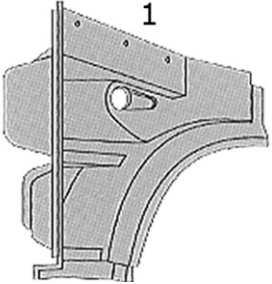



Section: 15, Pg: 24

1	590007	Step Panel L/H 1656925 1656927 1796244 1656923 1831060
1	590006	Step Panel R/H 1656924 1656928 1796245
2	509089	Footstep Bracket L/H 1642682 1695234
2	509088	Footstep Bracket R/H 1642683 1695235
3	509023	Upper Footstep Grille R/H & L/H 673144
4	509022	Centre Footstep Grille R/H & L/H 673143
5	509019	Lower Footstep Tread 962643 961229
6	509030	Footstep Bracket L/H 1641630
6	509029	Footstep Bracket R/H 1641631
7	590009	Window Regulator R/H Complete With Motor 1354703
8	590011	Door L/H 1676218 1304060
8	590010	Door R/H 1676219 1304061
9	509075	Door Handle Cover L/H 1305479
9	509074	Door Handle Cover R/H 1305480

10	509073	Door Handle L/H 1305481
10	509072	Door Handle R/H 1305482

Suffix Key; OE = Original Equipment, R = Reconditioned Equipment OEM = Original Equipment Manufacturer, ALT = Alternative Supplier Part

OE Numbers used for Cross Referencing Purposes Only

sales@direct-sourcing-solutions.com www.direct-sourcing-solutions.com

Tel; +44 (0) 1653 668179 Fax; +44 (0) 1905 507755

REAR WING - DAF 95XF 1997 > 2002 & 2ND SERIES 2002 > 2006 & XF 105

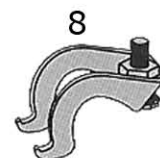
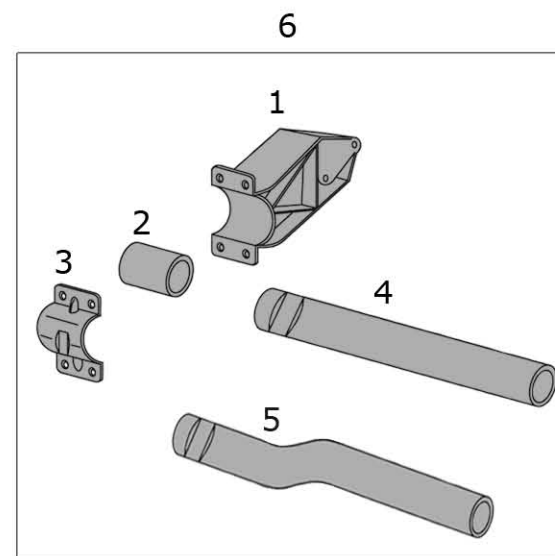
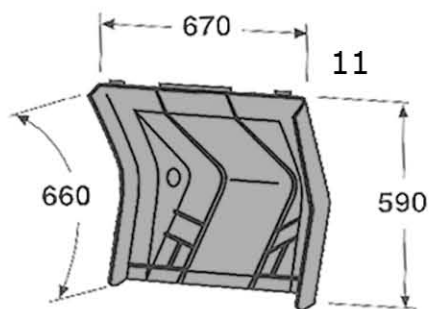
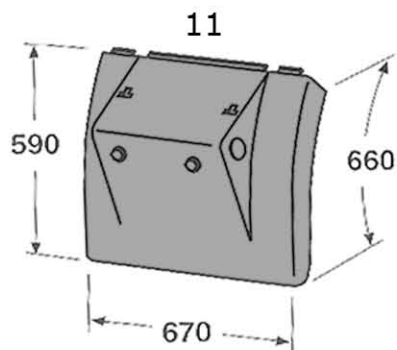
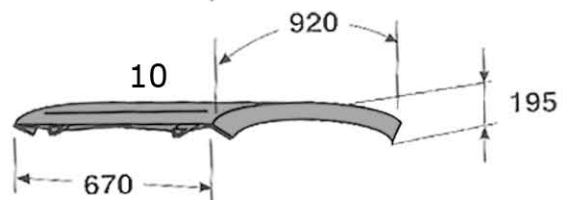
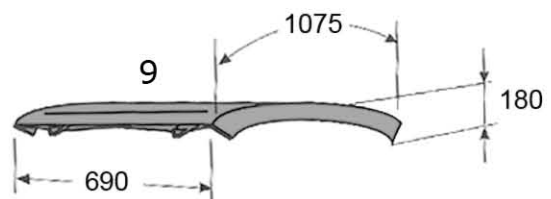



Section: 15, Pg: 26

1	509020	Rear Mudguard Bracket L/H & R/H (Aluminium) 1371224
2	590080	Mudguard Support Bracket Rubber Sleeve 1629045
3	509025	Mudguard Clamp Bracket (Steel) 1629046
4	509021	Rear Mudguard Support Bracket (Straight) 1610454 1371224
5	509024	Mudguard Support Bracket (Bent) 1629036
6	590085KIT	Rear Mudguard Bracket Kit
7	590072	Tensioner Strap Wing Top 1340450
8	590026	Tensioner Bracket Wing Top
9	590089	Rear Wing Top L/H & R/H 1875551 1875552
10	509077	Rear Wing Top L/H & R/H 1328935 1228935
11	509076	Rear Wing Section L/H & R/H 1328934

Suffix Key; OE = Original Equipment, R = Reconditioned Equipment OEM = Original Equipment Manufacturer, ALT = Alternative Supplier Part

OE Numbers used for Cross Referencing Purposes Only

sales@direct-sourcing-solutions.com www.direct-sourcing-solutions.com

Tel; +44 (0) 1653 668179 Fax; +44 (0) 1905 507755

MIRRORS - DAF CF SERIES, XF 95 03/2000 > 04/2006

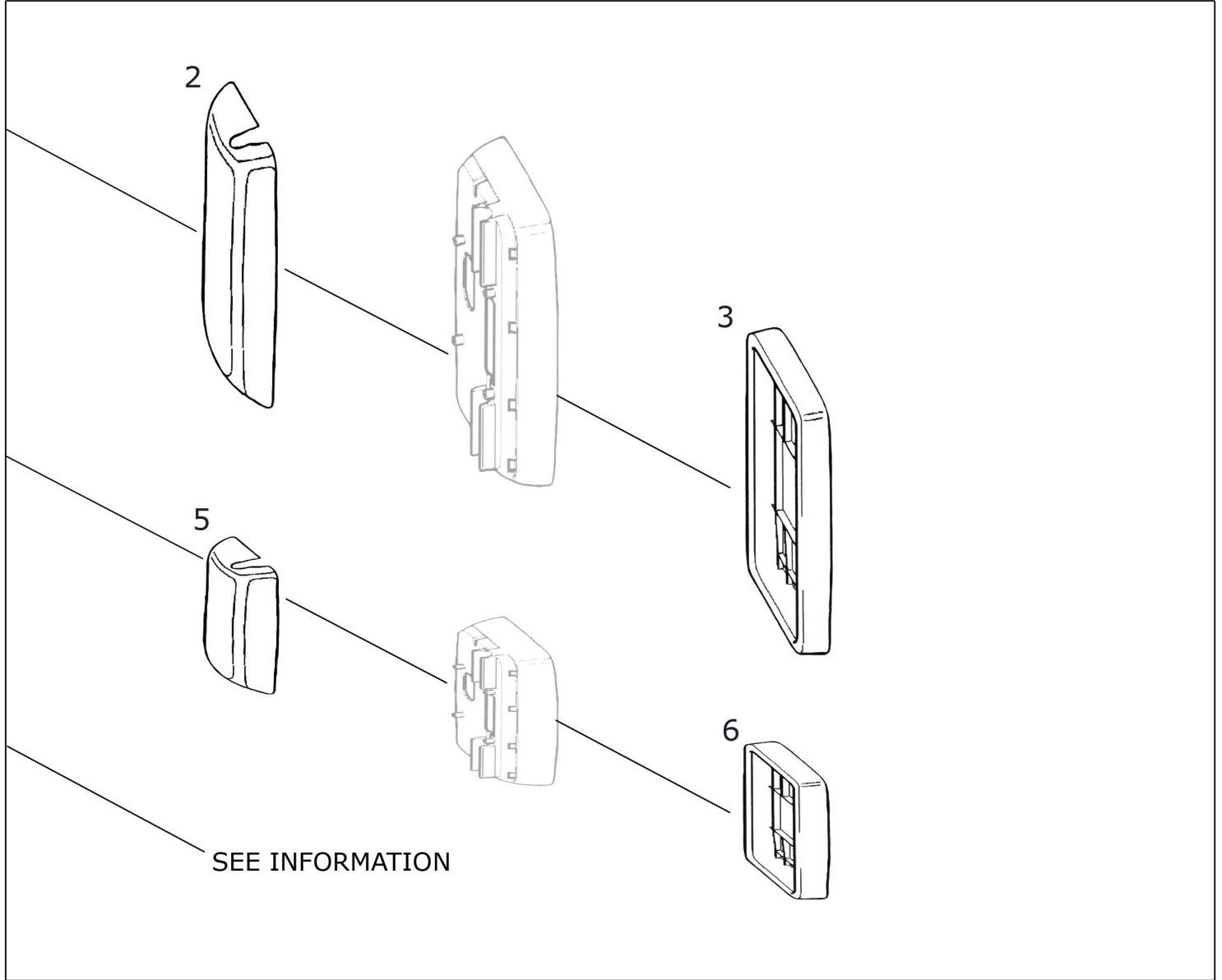
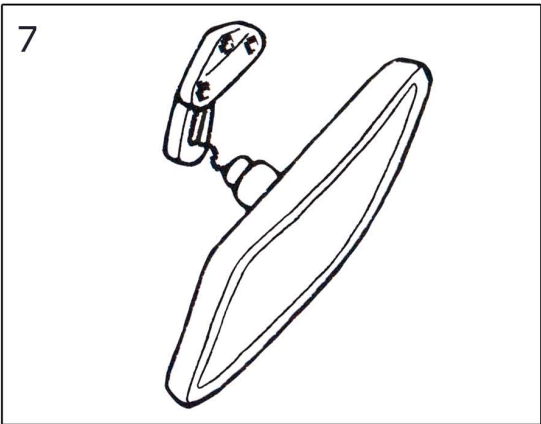
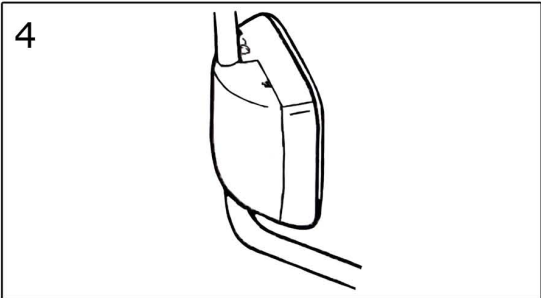
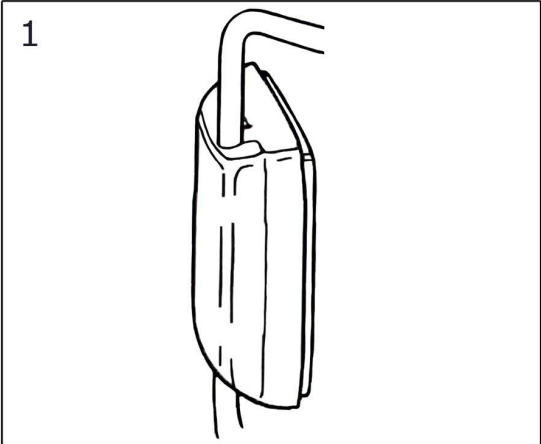



Section: 15, Pg: 28

1	590037	Complete Main Mirror Assembly L/H & R/H Non Heated Manual Adjustment 384 x 205mm 1425106
1	509186	Complete Main Mirror Assembly L/H & R/H Heated 24V Manual Adjustment 384 x 205mm 1425104 1610186
1	509132	Complete Main Mirror Assembly L/H & R/H Heated 24V Electrical Adjustment 384 x 205mm 1425105 1610184
2	509185	Main Mirror Cowl L/H & R/H 1425113 Alternatives; 509185OEM
3	509131	Main Mirror Glass L/H & R/H Heated 24V 370 x 190mm 1425109 1610190
4	590038	Complete Wide Angle Mirror Assembly L/H & R/H Non Heated Manual Adjustment 220 x 170mm
4	590039	Complete Wide Angle Mirror Assembly L/H & R/H Heated 24V Manual Adjustment 220 x 170mm 1425108 1610187 1610189
4	590040	Complete Wide Angle Mirror Assembly L/H & R/H Heated 24V Electrical Adjustment 220 x 170mm
5	509184	Wide Angle Mirror Cowl L/H & R/H 1425114
6	590041	Wide Angle Mirror Glass L/H & R/H Heated 24V 203 x 153mm 1425111 1610182 1610191

7	590046	Kerb Observation Mirror Kit 320x 190mm. 2 Holes In Bracket 1315311
7	509180	Kerb Observation Mirror Kit 320x 190mm. 3 Holes In Bracket 1614021

Suffix Key; OE = Original Equipment, R = Reconditioned Equipment OEM = Original Equipment Manufacturer, ALT = Alternative Supplier Part

OE Numbers used for Cross Referencing Purposes Only

sales@direct-sourcing-solutions.com www.direct-sourcing-solutions.com

Tel; +44 (0) 1653 668179 Fax; +44 (0) 1905 507755

MIRRORS - DAF LF SERIES 03/2000 > 04/2006

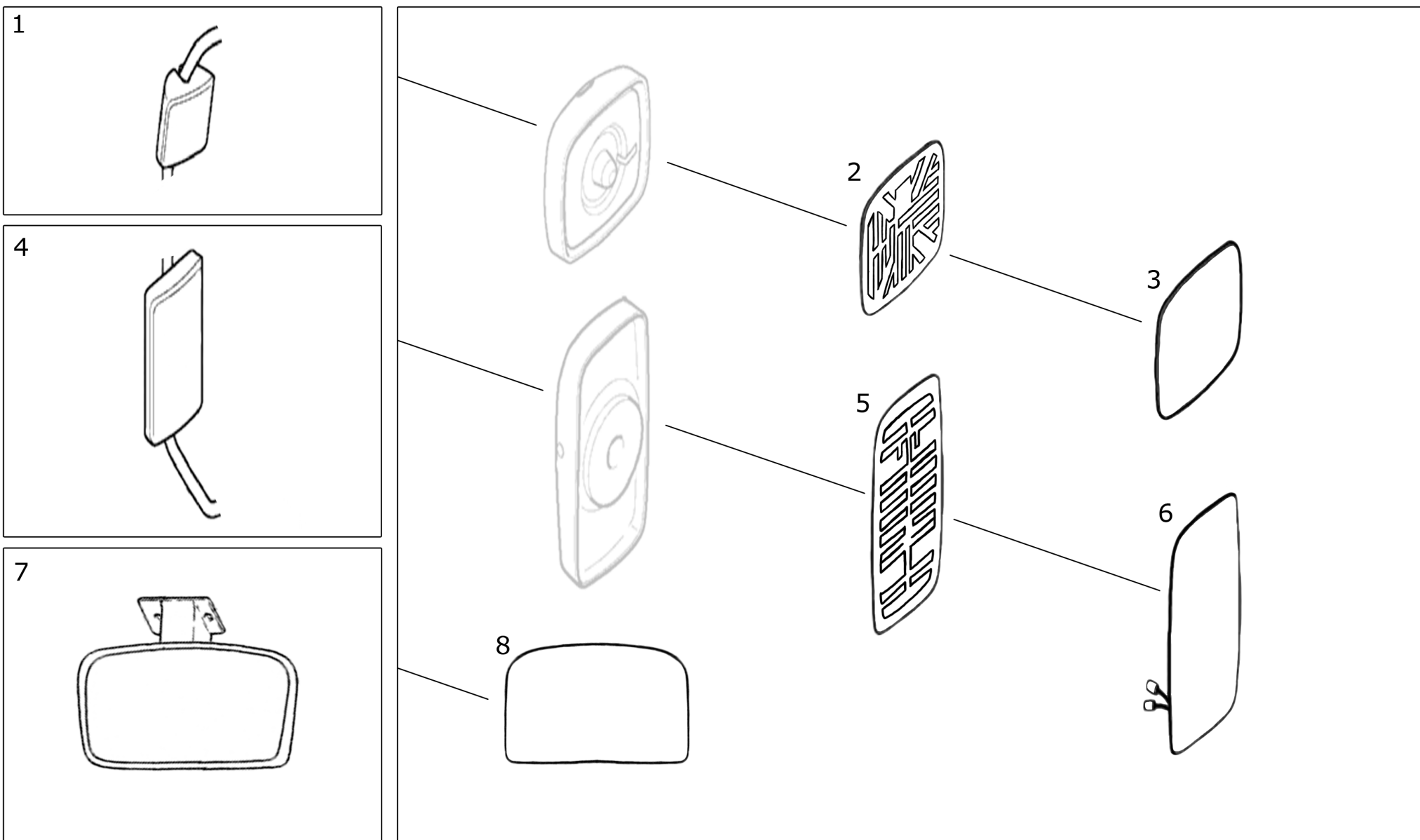



Section: 15, Pg: 30

1	590047	Complete Wide Angle Mirror Assembly L/H & R/H Heated 24V - New Radius 199 x 199mm 1796324
2	590048	Wide Angle Mirror Heating Element 24V 173 x 138mm.
3	590049	Wide Angle Mirror Glass L/H & R/H Heated 24V 189 x 189mm. 1796325
4	590050	Complete Main Mirror Assembly L/H & R/H Heated 24V Manual Adjustment 380 x 185mm 1404871
4	590051	Complete Main Mirror Assembly L/H & R/H Heated 24V Manual Adjustment 400 x 210mm 1620023
4	590052	Complete Main Mirror Assembly L/H & R/H Heated 24V & Electrical Adjustment 400 x 210mm. 1405601
5	590053	Main Mirror Heating Element 24V 300 x 150mm.
6	590054	Main Mirror Glass L/H & R/H Heated 24V 370 x 176mm. 1404872
6	590055	Main Mirror Glass L/H & R/H Heated 24V 369 x 180mm.
7	590056	Complete Kerb Mirror Assembly (New Regulation Glass) 290 x 170mm
8	590057	Kerb Mirror Glass 290 x 170mm

Suffix Key; OE = Original Equipment, R = Reconditioned Equipment OEM = Original Equipment Manufacturer, ALT = Alternative Supplier Part

OE Numbers used for Cross Referencing Purposes Only

sales@direct-sourcing-solutions.com www.direct-sourcing-solutions.com

Tel; +44 (0) 1653 668179 Fax; +44 (0) 1905 507755

MIRRORS - DAF LF SERIES 05/2006 >

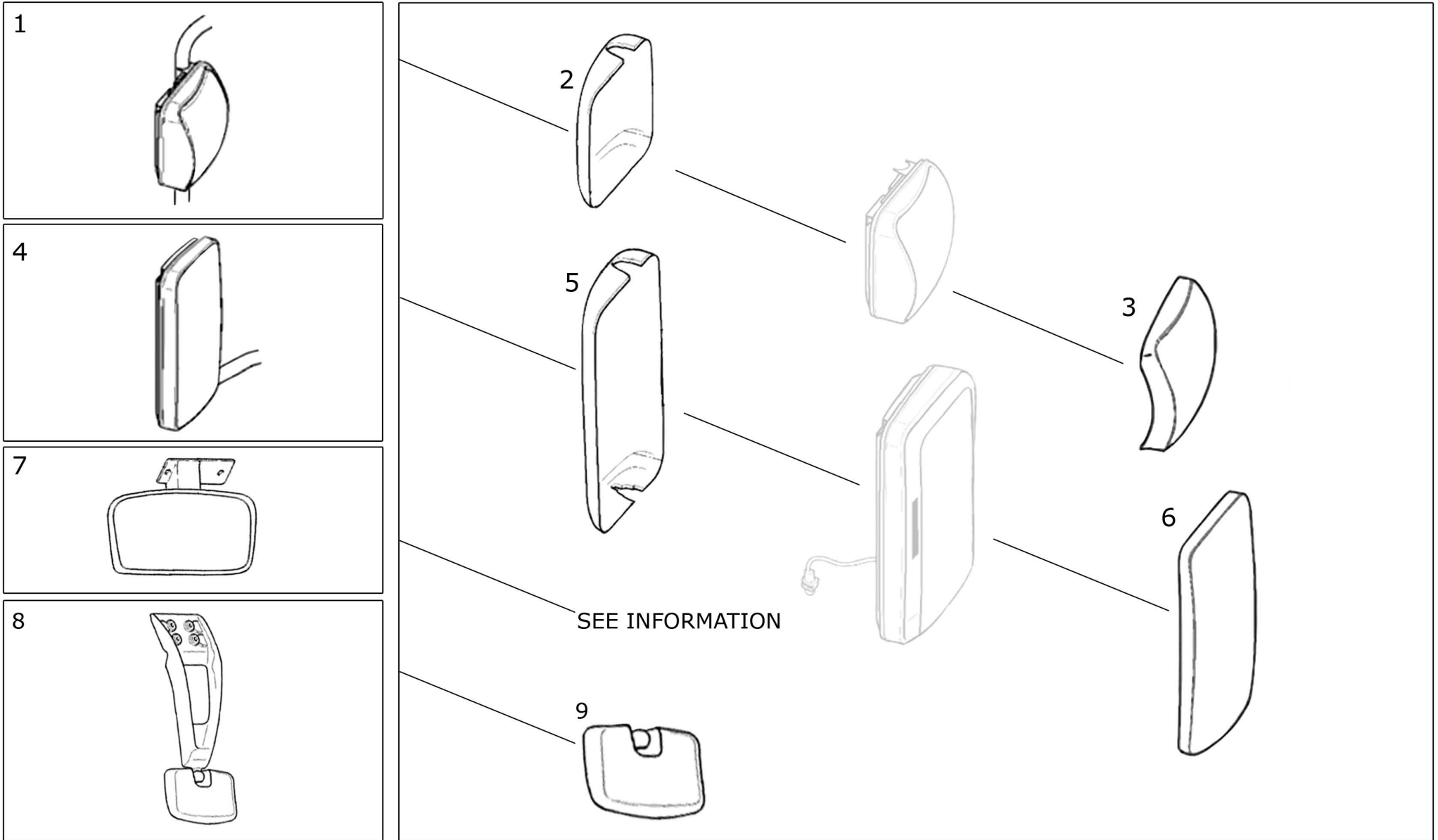



Section: 15, Pg: 32

- 1 **590058** Complete Wide Angle Mirror Assembly L/H
Heated 24V
245 x 230mm 1735522
- 1 **590059** Complete Wide Angle Mirror Assembly R/H
Heated 24V
245 x 230mm 1735523
- 2 **590060** Wide Angle Mirror Cowl L/H & R/H
1736883
- 3 **590061** Wide Angle Mirror Glass L/H Heated 24V
200 x 197mm 1736879
- 3 **590062** Wide Angle Mirror Glass R/H Heated 24V
200 x 197mm 1736865
- 4 **590063** Main Mirror Assembly L/H & R/H Heated 24V
Manual Adjustment
370 x 245mm 1735521
- 4 **590064** Main Mirror Assembly L/H & R/H Heated 24V
Electrical Adjustment
370 x 245mm 1735519
- 5 **590065** Main Mirror Cowl L/H & R/H
1736884
- 6 **590066** Main Mirror Glass Heated 24V
337 x 202mm 1737933
- 7 **590067** Kerb Mirror
260 x 229mm 1409570
- 8 **590068** Complete Front View Mirror Assembly
725 x 319 x 126mm 1701288

- 9 **590069** Front View Mirror
319 x 187mm 1746678

Suffix Key; OE = Original Equipment, R = Reconditioned Equipment OEM = Original Equipment Manufacturer, ALT = Alternative Supplier Part

OE Numbers used for Cross Referencing Purposes Only

sales@direct-sourcing-solutions.com www.direct-sourcing-solutions.com

Tel; +44 (0) 1653 668179 Fax; +44 (0) 1905 507755

MIRRORS - DAF XF 105 01/2006 >, CF SERIES 05/2006 >

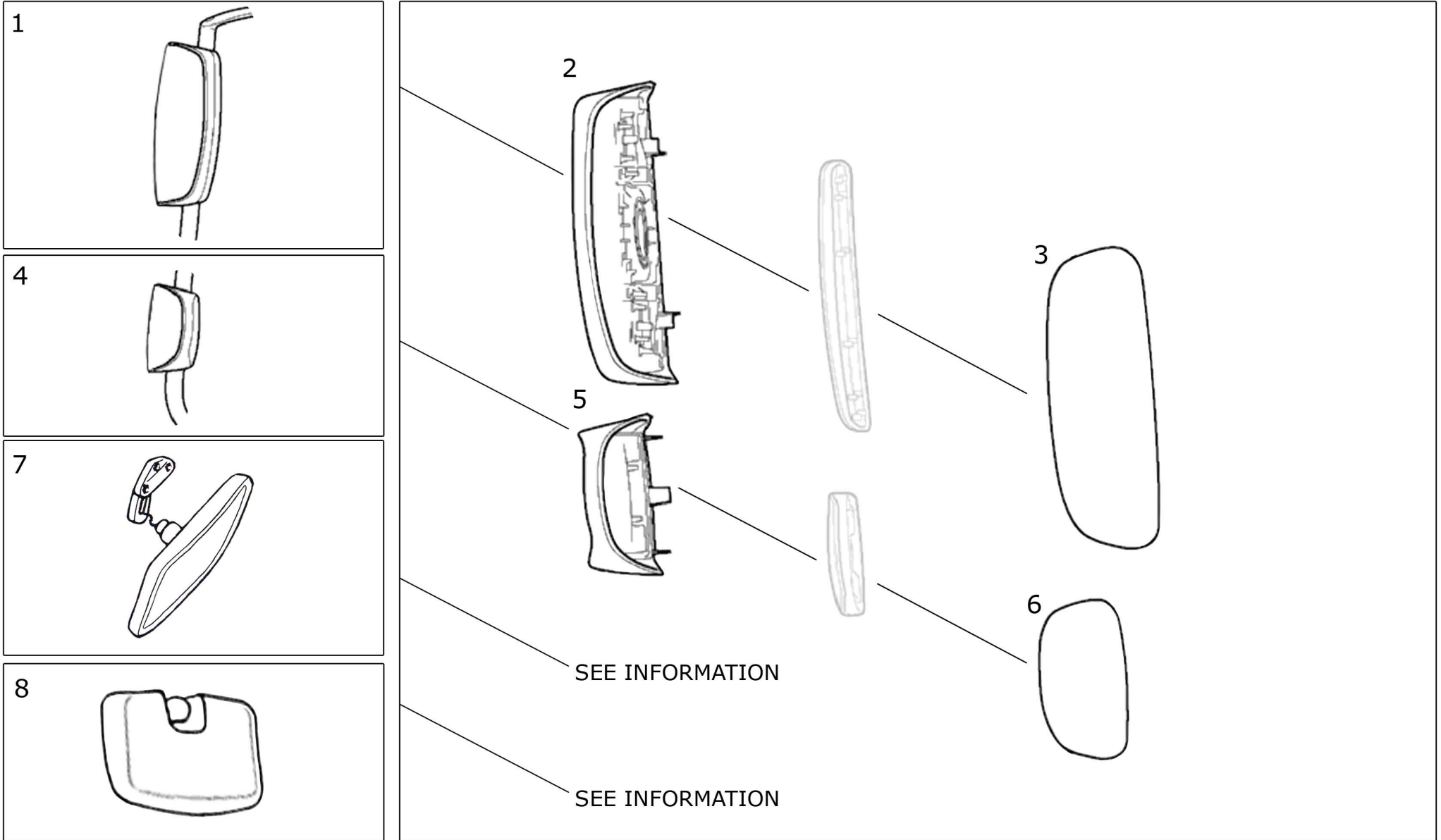



Section: 15, Pg: 34

1	509181	Complete Main Mirror Assembly L/H & R/H Heated 24V Manual Adjustment 411 x 228mm 1692557
1	509119	Complete Main Mirror Assembly L/H & R/H Heated 24V Electrical Adjustment 411 x 228mm 1689348
2	509123	Main Mirror Cowl L/H & R/H 1644325
3	509121	Main Mirror Glass Heated 24V L/H & R/H 363 x 177mm 1685330
4	509182	Complete Wide Angle Mirror Assembly L/H & R/H Heated 24V Manual Adjustment 239 x 221mm 1692556
4	509120	Complete Wide Angle Mirror Assembly L/H & R/H Heated 24V Electrical Adjustment 239 x 221mm 1689347
5	509124	Wide Angle Mirror Cowl L/H & R/H 1644326
6	509122	Wide Angle Mirror Glass L/H & R/H Heated 24V 207 x 161mm 1685331
7	509183	Kerb Observation Mirror (XF105 01/2006>) 320 x 190mm. 2 Holes In Bracket 1669573 1614022
7	509180	Kerb Observation Mirror (CF SERIES 05/2006>) 320 x 190mm. 3 Holes In Bracket 1614021
8	590069	Front View Mirror (XF105 01/2006> Super Space Cab) (CF Series 05/2006> Day Cab/Sleep Cab With & Without Sunvisor, Space Cab) 319 x 187mm 1746678

Suffix Key; OE = Original Equipment, R = Reconditioned Equipment OEM = Original Equipment Manufacturer, ALT = Alternative Supplier Part

OE Numbers used for Cross Referencing Purposes Only

sales@direct-sourcing-solutions.com www.direct-sourcing-solutions.com

Tel; +44 (0) 1653 668179 Fax; +44 (0) 1905 507755



Cab Mountings

<p>590083 1298675 1396202 1438837 Cab Suspension Bush F65, F75, F85, 65CF, 75CF, 85CF</p>	
<p>590070 1403089 Cab Suspension Bush F65, F75, F85, 65CF, 75CF, 85CF, LF45, LF55</p>	
<p>590045 1371070 Cab Suspension Rubber Bush F65, F75, F85, 65CF, 75CF, 85CF, CF75, CF85</p>	
<p>590071 365453 Cab Suspension Bush F95, 95XF, XF95, XF105</p>	
<p>590033 1332194 Cab Suspension Bolt F95, 95XF, XF95, XF105</p>	



Cab Shock Absorbers And Associated Parts

<p>590025 1377827 1265276 Front Cab Shock Absorber With Spring 75CF, 85CF, CF65, CF65II, CF65IV, CF75, CF75IV, CF85, CF85IV</p>	
<p>590021 1622211 1353450 Front Cab Shock Absorber, Air Suspended Cab XF95, XF105</p>	
<p>590002 1377828 1265272 1260942 Rear Cab Shock Absorber With Spring F65, F75, F85, F95, 65CF, 75CF, 85CF</p>	
<p>590024 1792419 1377826 Rear Cab Shock Absorber With Spring 95XF, LF55, CF65, CF65II, CF65IV, CF75, CF75IV, CF85, CF85IV</p>	
<p>590017 1792423 1623477 1353451 Rear Cab Shock Absorber XF95, XF105</p>	

Suffix Key; OE = Original Equipment, R = Reconditioned Part
OEM = Original Equipment Manufacturer, ALT = Alternative Supplier Part

OE Numbers used for Cross Reference Purposes Only

sales@direct-sourcing-solutions.com www.direct-sourcing-solutions.com

Tel; +44 (0) 1653 668179 Fax; +44 (0) 1905 507755

Section: 15, Pg: 36





Cab Level Valves And Link Rods

<p>590034OEM 1341990 1445900 1600469 1604351 759050 Cab Level Valve 75CF, 95XF, LF55, CF65, CF75, CF85, XF95, XF105</p>	



Cab Jack Rams

<p>509008 1346200 1308300 Cab Ram F95, 95XF, XF95, XF105 2 x Port</p>	
---	---

<p>590090 1439151 Cab Ram 95XF, LF55, CF65, CF65II, CF65IV, CF75, CF75IV</p>	
--	---

<p>509009 1444742 Cab Ram XF95, XF105 3 x Port</p>	<p style="text-align: center;">Alternatives; 509009OEM</p> 
--	---

--	--

--	--



Cab Filters

<p>590005 1791192 1362124 Cab Filter 65CF, 75CF, 85CF, CF65, CF65II, CF65IV, CF75, CF75IV, CF85, CF85IV</p>	
---	---

<p>590004 1825431 1362168 Cab Filter CF65, CF75, CF85</p>	
---	---

<p>590003 1825427 1658991 1347066 1322255 Cab Filter 95XF, XF95, XF105</p>	
--	---

--	--

--	--

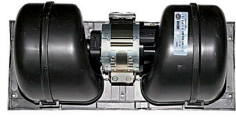

Heater Equipment

<p>580006OEM 1672646 1331270 1262851 Heater Motor F65, F75, F85, F95, 65CF, 75CF, 85CF, 95XF, XF95, XF105</p>	
---	---

<p>590086 1373855 1635854 1788494 Heater Motor Resistor 65CF, 75CF, 85CF, CF65, CF65II, CF65IV, CF75, CF75IV, CF85, CF85IV, XF95, XF105</p>	
---	---

<p>520001OEM 1454123 Heater Radiator 65CF, 6/8/11 Ltr, 75CF, 85CF, CF65, CF65II, CF65IV, CF75, CF75IV, CF85, CF85IV, XF95, XF105 Pin Fix</p>	
--	---

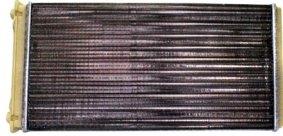
<p>590029 1335401 1331272 1262853 Heater Radiator F65, F75, F85, F95, 65CF, 75CF, 85CF, 95XF, XF95, XF105</p>	
---	---

--	--



Air Conditioning Radiators And Associated Parts

<p>590084 1321833 Condensing Radiator F95, 95XF</p>	
---	---

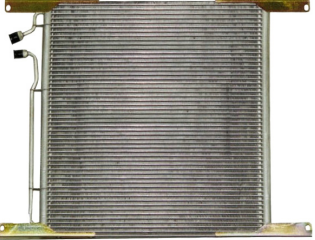
<p>590073 1371355 Condensing Radiator 65CF, 75CF, 85CF, CF65, CF75, CF75IV, CF85, CF85IV 455 x 432 x 16mm</p>	
---	---

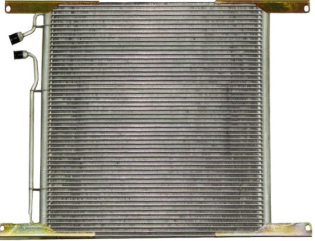
<p>590081 1629115 Condensing Radiator XF95, XF105 490 x 540 x 16mm</p>	
--	---

--	--

--	--



Wipers, Washers And Associated Parts

<p>590008OEM ABU8833 Wiper Blade 550mm F45, F55</p>	
<p>590087 1238779 Wiper Arm With Nozzle F95, 95XF, XF95, XF105</p>	
<p>580002 1343064 Washer Pump F65, F75, F85, F95, 65CF, 75CF, 85CF, 95XF, CF65, CF65II, CF65IV, CF75, CF75IV, CF85, CF85IV, XF95, XF105</p>	
<p>580013 384984 Headlamp Washer Pump F800, F1000, F1100, F1300, F1600, F1700, F1800, F1900, F2100, F2300, F2500, F2700, F95, 95XF, CF65, CF65IV, CF75, CF75IV, CF85, CF85IV, XF95, XF105</p>	
<p>590079 1253523 Windscreen Washer Jet F95, 95XF, XF95, XF105</p>	



Window Regulators

590013

1374568

Window Regulator Complete With Motor L/H

CF65, CF75, CF85

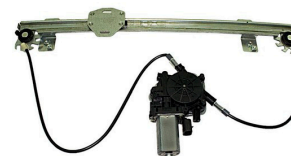

590014

1374569

Window Regulator Complete With Motor R/H

CF65, CF75, CF85

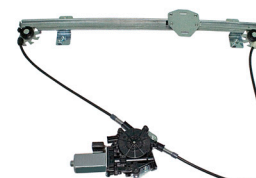

590012

1354702

Window Regulator Complete With Motor L/H

F95, 95XF, XF95, XF105

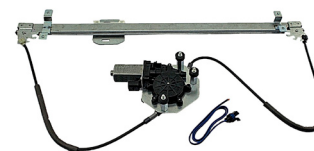

590009

1354703

Window Regulator Complete With Motor R/H

F95, 95XF, XF95, XF105

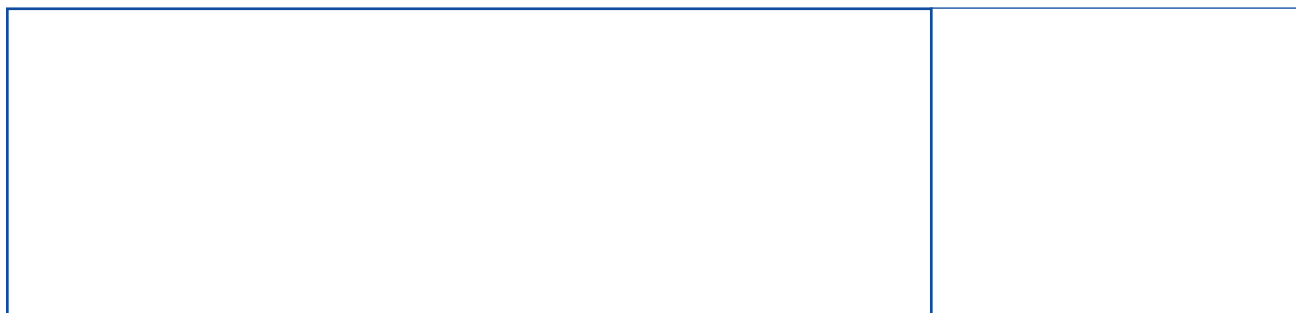
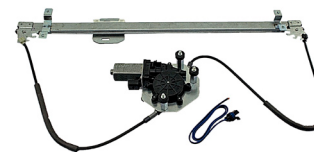

Suffix Key; OE = Original Equipment, R = Reconditioned Part
OEM = Original Equipment Manufacturer, ALT = Alternative Supplier Part

OE Numbers used for Cross Reference Purposes Only

sales@direct-sourcing-solutions.com www.direct-sourcing-solutions.com

Tel; +44 (0) 1653 668179 Fax; +44 (0) 1905 507755

Section: 15, Pg: 44



As A UK Distributor Of KAB Seating
We Stock A Range Of Universal Seats
And Adaptor Brackets To Suit Most
Makes Of Commercial Vehicle; Please
Contact Us For Details.

Suffix Key; OE = Original Equipment, R = Reconditioned Part

OEM = Original Equipment Manufacturer, ALT = Alternative Supplier Part

OE Numbers used for Cross Reference Purposes Only

sales@direct-sourcing-solutions.com www.direct-sourcing-solutions.com

Tel; +44 (0) 1653 668179 Fax; +44 (0) 1905 507755

Section: 15, Pg: 45



Seats, Fittings And Associated Parts

<p>209742</p> <p>Drivers Air Seat, No Seat Belt, Complete With Runners - KAB 712</p>	
<p>209744</p> <p>Drivers Air Seat, No Seat Belt - KAB 714</p>	
<p>209704</p> <p>Drivers Air Seat Complete With Seat Belt & Headrest - KAB 714B</p>	
<p>290020</p> <p>Drivers Air Seat Complete With Seat Belt & Headrest LHD L/H</p>	
<p>290040</p> <p>Drivers Air Seat Complete With Seat Belt & Headrest (Luxury) - KAB GSX300</p>	

Suffix Key; OE = Original Equipment, R = Reconditioned Part
OEM = Original Equipment Manufacturer, ALT = Alternative Supplier Part

OE Numbers used for Cross Reference Purposes Only



sales@direct-sourcing-solutions.com www.direct-sourcing-solutions.com

Tel; +44 (0) 1653 668179 Fax; +44 (0) 1905 507755

Section: 15, Pg: 46



Seats, Fittings And Associated Parts

<p>209737</p> <p>Headrest</p>	
<p>209752</p> <p>Seat Z-Bracket KAB 150380</p>	
<p>590027</p> <p>1331730</p> <p>Seat Cylinder</p> <p>F65, F75, F85, F95, 65CF, 75CF, 85CF, 95XF, CF65, CF65II, CF65IV, CF75, CF75IV, CF85, CF85IV, XF95, XF105</p>	

Direct Sourcing Solutions

DAF Catalogue 5.14.1



This Page Is Intentionally Left Blank

Suffix Key; OE = Original Equipment, R = Reconditioned Part
OEM = Original Equipment Manufacturer, ALT = Alternative Supplier Part

OE Numbers used for Cross Reference Purposes Only

sales@direct-sourcing-solutions.com www.direct-sourcing-solutions.com

Tel; +44 (0) 1653 668179 Fax; +44 (0) 1905 507755

Direct Sourcing Solutions

DAF Catalogue 5.14.1

16: Electrical Index



Alternators And Associated Parts	Pg: 2
Battery Covers	Pg: 1
Lighting; Fog, Spot And Working Lamps	Pg: 8-10
Lighting; Front Parking/Marker Lamps	Pg: 6
Lighting; Headlamps And Associated Parts	Pg: 4-5
Lighting; Indicator Lamps And Lenses	Pg: 7
Lighting; Rear Lamps And Lenses	Pg: 11-12
Miscellaneous Electrical Parts	Pg: 15
Starter Motors And Associated Parts	Pg: 3
Switches; Steering Column And Ignition Switches	Pg: 13
Washer And Wiper Equipment; Wiper Switches And Motors	Pg: 14

Suffix Key; OE = Original Equipment, R = Reconditioned Part
OEM = Original Equipment Manufacturer, ALT = Alternative Supplier Part

OE Numbers used for Cross Reference Purposes Only

sales@direct-sourcing-solutions.com www.direct-sourcing-solutions.com

Tel; +44 (0) 1653 668179 Fax; +44 (0) 1905 507755



Battery Covers

508372

1745335 1732653 1603386 287973

Battery Cover

CF75, CF75IV, CF85, CF85IV, XF95, XF105

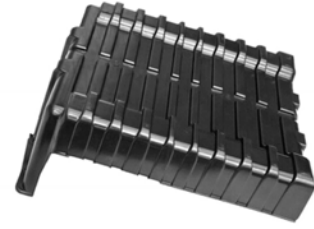

580016

1667885 1693114

Battery Cover

CF75IV, CF85IV, XF95, XF105



580023

630960

Battery Tensioner Strap

CF75IV, CF85IV, XF95, XF105

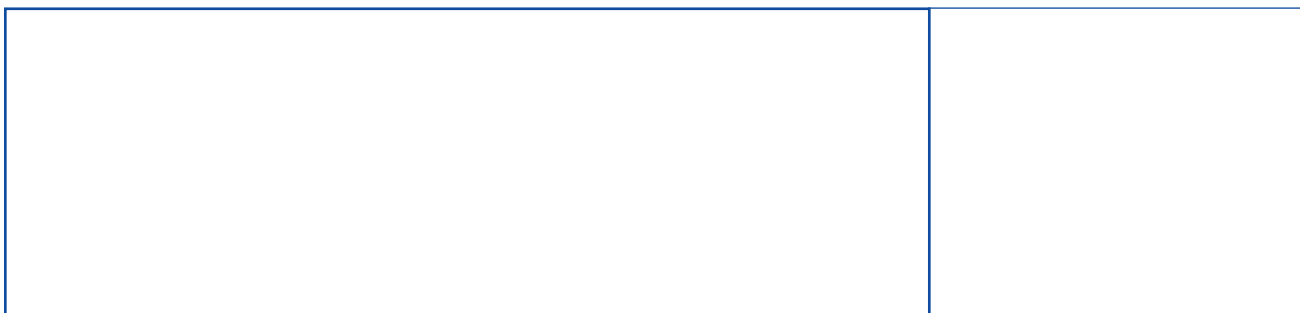
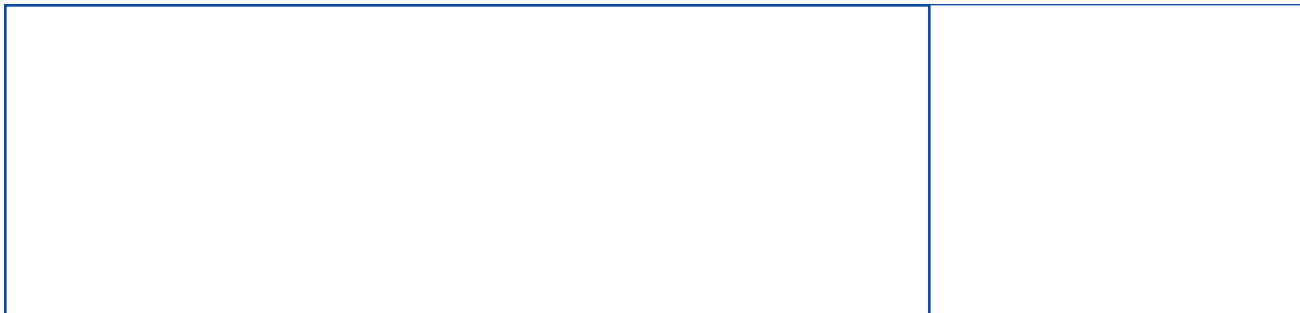

Suffix Key; OE = Original Equipment, R = Reconditioned Part
OEM = Original Equipment Manufacturer, ALT = Alternative Supplier Part

OE Numbers used for Cross Reference Purposes Only

sales@direct-sourcing-solutions.com www.direct-sourcing-solutions.com

Tel; +44 (0) 1653 668179 Fax; +44 (0) 1905 507755

Section: 16, Pg: 1



Alternators And Associated Parts

510028

1368327 1697321

Alternator 100 Amp

75CF, CF75, CF85, XF95



580030

1626130

Alternator 80 Amp

CF85IV, XF95, XF105



580020

1627625 1694953 1695242

Alternator Belt Tensioner

CF85IV, XF95, XF105



508001

750114

Alternator Fan

F2800, F2900, F3200, F3300, F3600, F65, F75, F85, F95, 65CF, 75CF, 85CF, XF95



508000

1289353

Alternator Pulley

F65, F75, 65CF, 75CF, 6/8/11 Ltr



Suffix Key; OE = Original Equipment, R = Reconditioned Part

OEM = Original Equipment Manufacturer, ALT = Alternative Supplier Part

OE Numbers used for Cross Reference Purposes Only

sales@direct-sourcing-solutions.com www.direct-sourcing-solutions.com

Tel; +44 (0) 1653 668179 Fax; +44 (0) 1905 507755

Section: 16, Pg: 2



Starter Motors And Associated Parts

580003

1357212 1284775

Starter Motor

85CF, 95XF, CF85, CF85IV, XF95



580008

1318615 1357210 1317220

Starter Motor

85CF, 95XF



580012

1387383 1387381

Starter Motor

CF65



580019

1604246 1667205 1688720 1739936

Starter Motor

CF85, CF85IV, XF95, XF105



580007

1843852 1826121 1739935

Starter Motor

CF85IV, XF105



Suffix Key; OE = Original Equipment, R = Reconditioned Part
OEM = Original Equipment Manufacturer, ALT = Alternative Supplier Part

OE Numbers used for Cross Reference Purposes Only

sales@direct-sourcing-solutions.com www.direct-sourcing-solutions.com

Tel; +44 (0) 1653 668179 Fax; +44 (0) 1905 507755

Section: 16, Pg: 3





Lighting; Headlamps And Associated Parts

<p>508102 Alternatives; 508102OEM 1743686 1699302 1641744 Headlamp L/H Complete With Adjuster Motor 65CF, 75CF, 85CF, CF65, CF75, CF85, XF95, XF105</p>	
<p>508103 Alternatives; 508103OEM 1743687 1699303 1641745 Headlamp R/H Complete With Adjuster Motor 65CF, 75CF, 85CF, CF65, CF75, CF85, XF95, XF105</p>	
<p>509067 1641742 Headlamp L/H 75CF, 85CF, CF65, CF75, CF75IV, CF85, CF85IV, XF95, XF105</p>	
<p>509066 1641743 Headlamp R/H 75CF, 85CF, CF65, CF75, CF75IV, CF85, CF85IV, XF95, XF105</p>	
<p>508100 1743688 1699305 1641746 Headlamp L/H Without Level Adjuster CF65IV, CF75, CF75IV, CF85, CF85IV, XF95, XF105</p>	



Lighting; Headlamps And Associated Parts

<p>508101 1743689 1699306 1641747 Headlamp R/H Without Level Adjuster CF65IV, CF75, CF75IV, CF85, CF85IV, XF95, XF105</p>	
--	---

<p>580013 384984 Headlamp Washer Pump F800, F1000, F1100, F1300, F1600, F1700, F1800, F1900, F2100, F2300, F2500, F2700, F95, 95XF, CF65IV, CF75IV, CF85IV, XF95, XF105</p>	
--	---

--	--

--	--

--	--



Lighting; Front Parking/Marker Lamps

<p>580017 1403887 Front Positioning Lamp LF45, LF55</p>	



Lighting; Indicator Lamps And Lenses

<p>580001 1815754 1814096 Side Indicator Lamp CF65, CF65II, CF65IV, CF75, CF75IV, CF85, CF85IV, XF105</p>	
<p>580018 1626101 1404747 Side Indicator Lamp L/H & R/H LF45, LF45IV, LF55, LF55IV</p>	
<p>508010 66698 Corner Lamp F800, F1000, F1100, F1300, F1600, F1700, F1800, F1900, F2100, F2300, F2500, F2700, F95</p>	
<p>508011 1301368 Corner Lamp F95, 95XF, XF95</p>	

Suffix Key; OE = Original Equipment, R = Reconditioned Part
OEM = Original Equipment Manufacturer, ALT = Alternative Supplier Part

OE Numbers used for Cross Reference Purposes Only

sales@direct-sourcing-solutions.com www.direct-sourcing-solutions.com

Tel; +44 (0) 1653 668179 Fax; +44 (0) 1905 507755

Section: 16, Pg: 7



Lighting; Fog, Spot And Working Lamps

508271

1328860

Fog /Spot Lamp L/H

F95, 65CF, 75CF, 85CF, 95XF, LF45, LF55, CF65, CF75, CF85, XF95



508270

1328861

Fog /Spot Lamp R/H

F95, 65CF, 75CF, 85CF, 95XF, LF45, LF55, CF65, CF75, CF85, XF95



509069

1328061

Fog Lamp L/H

F95, 65CF, 75CF, 85CF, 95XF, LF45, LF55, CF65, CF75, CF85, XF95



509068

1328060

Fog Lamp R/H

F95, 65CF, 75CF, 85CF, 95XF, LF45, LF55, CF65, CF75, CF85, XF95



590031

1725272

Spot Lamp L/H

LF45IV, LF55IV, CF65IV, CF75IV, CF85IV



Suffix Key; OE = Original Equipment, R = Reconditioned Part

OEM = Original Equipment Manufacturer, ALT = Alternative Supplier Part

OE Numbers used for Cross Reference Purposes Only

sales@direct-sourcing-solutions.com www.direct-sourcing-solutions.com

Tel; +44 (0) 1653 668179 Fax; +44 (0) 1905 507755

Section: 16, Pg: 8



Lighting; Fog, Spot And Working Lamps

590032

1725273

Spot Lamp R/H

LF45IV, LF55IV, CF65IV, CF75IV, CF85IV



509071

1725270 1660960

Fog /Spot Lamp L/H

XF95, XF105



509070

1725271 1660961

Fog /Spot Lamp R/H

XF95, XF105



580004

1792958

Auxiliary Lamp L/H

CF75IV, CF85IV



580005

1792959

Auxiliary Lamp R/H

CF75IV, CF85IV



Suffix Key; OE = Original Equipment, R = Reconditioned Part
OEM = Original Equipment Manufacturer, ALT = Alternative Supplier Part

OE Numbers used for Cross Reference Purposes Only

sales@direct-sourcing-solutions.com www.direct-sourcing-solutions.com

Tel; +44 (0) 1653 668179 Fax; +44 (0) 1905 507755

Section: 16, Pg: 9



Lighting; Fog, Spot And Working Lamps

<p>508104 1733057 Combination Lamp L/H XF105</p>	
--	---

<p>508105 1733058 Combination Lamp R/H XF105</p>	
--	---

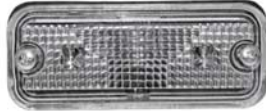
<p>580010 1454669 1328865 384991 Position Lamp F800, F1000, F1100, F1300, F1600, F1700, F1800, F1900, F2100, F2300, F2500, F2700, F95, 95XF, XF95, XF105</p>	
--	---

--	--

--	--



Lighting; Rear Lamps And Lenses

<p>580014 1283371 1284211 1291216 1304789 Combination Tail Lamp L/H F75, F85, F95, 65CF, 75CF, 85CF, 95XF, CF65, CF75, CF85, XF95</p>	
<p>580015 1284212 1291215 1304788 Combination Tail Lamp R/H F75, F85, F95, 65CF, 75CF, 85CF, 95XF, CF65, CF75, CF85, XF95</p>	
<p>580024 1875577 Tail Lamp L/H With Number Plate Lamp CF75IV, CF85IV, XF105 Side Connector</p>	
<p>580025 1875576 Tail Lamp R/H CF75IV, CF85IV, XF105 Side Connector</p>	
<p>580026 1875578 Tail Lamp R/H With Reverse Alarm CF75IV, CF85IV, XF105 Side Connector</p>	

Suffix Key; OE = Original Equipment, R = Reconditioned Part
OEM = Original Equipment Manufacturer, ALT = Alternative Supplier Part

OE Numbers used for Cross Reference Purposes Only

sales@direct-sourcing-solutions.com www.direct-sourcing-solutions.com

Tel; +44 (0) 1653 668179 Fax; +44 (0) 1905 507755

Section: 16, Pg: 11





Lighting; Rear Lamps And Lenses

<p>580027 1875580 Tail Lamp L/H With Number Plate Lamp CF75IV, CF85IV, XF105 Rear Connector</p>	
<p>580028 1875579 Tail Lamp R/H CF75IV, CF85IV, XF105 Rear Connector</p>	
<p>580029 1875581 Tail Lamp R/H With Reverse Alarm CF75IV, CF85IV, XF105 Rear Connector</p>	
<p>580021 1914690 Combination Tail Lamp Lens L/H CF75IV, CF85IV, XF105</p>	
<p>580022 1914691 Combination Tail Lamp Lens R/H CF75IV, CF85IV, XF105</p>	



Switches; Steering Column And Ignition Switches

<p>508298 1615082 1440216 1390126 1301878 1230991 370239 Indicator Switch F800, F1000, F1100, F1300, F1600, F1700, F1800, F1900, F2100, F2300, F2500, F2700, F65, F75, F85, F95, 65CF, 75CF, 85CF, CF75, CF85</p>	
---	---

<p>508297 1615081 Indicator Switch XF95</p>	
--	---

<p>508296 1811123 1801933 1669662 1452988 1439488 1615080 Combination Switch 75CF, 85CF, 95XF, XF95, XF105</p>	
---	---

--	--

--	--



Washer And Wiper Equipment; Wiper Switches And Motors

<p>580011 1705212 1405321 Washer Switch LF45, LF45IV, LF55, LF55IV</p>	
--	---

<p>580009 Alternatives; 580009OEM 1254891 403924 97938 Wiper Motor F800, F1000, F1100, F1300, F1600, F1700, F1800, F1900, F2100, F2300, F2500, F2700, F2800, F2900, F3200, F3300, F3600, N2800, F95, 95XF, XF95, XF105</p>	
---	---

<p>590030 Alternatives; 590030OEM 1620100 Wiper Motor CF65, CF75, CF85</p>	
---	---

--	--

--	--



Miscellaneous Electrical Parts

508008

1249459

Horn Disc Type

F65, F75, F85, 65CF, 75CF, 85CF, LF45, LF55, CF65, CF75, CF75IV, CF85,
CF85IV, 6/8/11 Ltr



Suffix Key; OE = Original Equipment, R = Reconditioned Part

OEM = Original Equipment Manufacturer, ALT = Alternative Supplier Part

OE Numbers used for Cross Reference Purposes Only

sales@direct-sourcing-solutions.com www.direct-sourcing-solutions.com

Tel; +44 (0) 1653 668179 Fax; +44 (0) 1905 507755

Section: 16, Pg: 15

Direct Sourcing Solutions Ltd trading as DSS - Terms and Conditions of Sale

GENERAL

These conditions prevail over any conditions which the purchaser's order may purport to impose and which are at variance with the same. No modifications shall be binding upon Direct Sourcing Solutions Limited unless specifically accepted in writing. Direct Sourcing Solutions Ltd will be referred to as DSS hereafter. Typing and clerical errors are subject to correction. All orders or contracts are subject to acceptance by DSS at its office at Kirby Misperton, Malton, regardless if taken elsewhere by a sales person or a selling agent. Quotations do not constitute an offer and shall not bind DSS, until an order has been placed and accepted.

PAYMENT

Unless other terms are expressly agreed upon, payment is Nett 30 days monthly account. DSS reserves the right to impose on the buyer the special term "Cash on Delivery", if it considers it necessary. Payment should be made to Direct Sourcing Solutions Ltd. In addition to its other remedies DSS, reserves the right to charge interest on delayed payment from the due date on a daily basis at Fortis Bank plc base rate from time to time in force plus three percent.

PROPERTY

Notwithstanding delivery and the passing of risk in the goods, the property in the goods shall not pass to the buyer until DSS has received in cash or cleared funds payment in full of the price of the goods sold or agreed to be sold by DSS to the buyer under the contract.

Until the property in the goods passes to the buyer:

- a) the buyer shall hold the goods as DSS bailee, and shall keep those goods separate from all other goods and property stored, protected and insured and identified as DSS's property and
- b) the buyer shall be entitled to resell or use the goods in the ordinary course of its business, but shall have a fiduciary duty to DSS to account for the proceeds of sale or otherwise of the goods, whether tangible or intangible, including insurance proceeds, and shall keep all such proceeds separate from any monies or property of the buyer and third parties and , in the case of tangible proceeds, property stored, protected and insured; and
- c) DSS shall be entitled at any time to require the buyer to deliver up the goods to DSS and, if the buyer fails to do so forthwith, to enter upon any premises of the buyer or any third party where the goods are stored and repossess the goods and for that purpose the buyer hereby authorises and licences DSS to enter upon any land or building upon which the goods are situated to recover those goods.

The buyer shall not be entitled to or in any way charge by way of security for any indebtedness any of the goods which remain the property of DSS, but if the buyer does so all monies owing by the buyer to DSS shall, without prejudice to any other right or remedy of DSS, forthwith become due and payable.

INSPECTION AND RETURN OF GOODS

If upon receipt of goods from DSS the goods do not appear to conform to specifications, the buyer must notify DSS within 5 working days after receipt in writing. The return of correctly supplied goods when accepted by DSS will incur a charge of 20% of the value of the goods excluding VAT at current rate. Goods supplied as special orders are not returnable. Goods cannot be returned without prior authorisation from DSS.

EXCHANGE ITEMS

A surcharge is levied on the exchange items (e.g. items that can be reconditioned). The surcharge is refundable subject to the following conditions:

- a) The exchange items are returned within 10 days.
- b) The exchange items are not broken, damaged or dismantled.

TELEPHONED ORDERS

Verbal or telephoned orders, or any variation, must be confirmed in writing by the Buyer otherwise DSS accept no responsibility for errors or subsequent misunderstandings. DSS assumes no responsibility for any orders which are duplicated, as a result of a confirming order not being identified as such.

ORDER CLASSIFICATION

VOR emergencies must be negotiated at the time of the order being placed. If the order product is available, it will be dispatched the same day, providing the order is received early enough to allow dispatch. We request VOR orders to be placed before 4.00pm

CATALOGUE, PRICE LIST AND OTHER ADVERTISEMENT MATTERS

Catalogues, price lists and other material used for advertising are only an indication of the type of goods, and no other particulars contained therein shall be binding to DSS.

VAT

Unless otherwise stated, all prices quoted by DSS do not include value added tax at the current rate.

PRICES

DSS reserves the right to vary the quoted price and goods will be invoiced at the price ruling at the day of dispatch unless otherwise agreed by DSS in writing.

DELIVERY DATES

Whilst DSS will do its utmost to keep its promised delivery dates, they are to be treated as estimates only. DSS accept no responsibility for loss or damage resulting from delay in the delivery of goods. Delays due to circumstances outside the control of DSS shall not entitle the buyer to cancel any order or to refuse to accept delivery.

WARRANTY CLAIM

In the event of a warranty claim DSS must be promptly notified in writing on the appropriate DSS form, and will only accept claims due to faulty materials or workmanship. Goods must be returned carriage paid for immediately upon the discovery of the defect. No credit will be given until such time as DSS is satisfied that such defects arose solely through mentioned causes and DSS has received credit from the manufacturer or supplier. DSS shall in no circumstances be liable for any consequential loss or damages. All replacement items for warranty claims will be booked out at the current DSS price.

DELIVERY CLAIMS

Damage in transit or shortage must be reported within 7 days of receipt of goods or, in the case of an undelivered consignment, within 7 days of the invoice date.

Direct Sourcing Solutions

DAF Catalogue 5.14.1



This Page Is Intentionally Left Blank

Suffix Key; OE = Original Equipment, R = Reconditioned Part
OEM = Original Equipment Manufacturer, ALT = Alternative Supplier Part

OE Numbers used for Cross Reference Purposes Only

sales@direct-sourcing-solutions.com www.direct-sourcing-solutions.com

Tel; +44 (0) 1653 668179 Fax; +44 (0) 1905 507755



DIRECT SOURCING SOLUTIONS LTD
Unit 8A
Beansheaf Industrial Park
Tofts Road
Kirby Misperton
Malton
N.Yorkshire
YO17 6BG

Tel: +44 (0)1653 668179
Fax: +44 (0)1905 507755
www.direct-sourcing-solutions.com
email: sales@direct-sourcing-solutions.com