

Direct Sourcing Solutions Ltd



Renault Replacement Parts



6.14.1

www.direct-sourcing-solutions.com
E mail: sales@direct-sourcing-solutions.com



1: Engine	1
2: Cooling	2
3: Fuel	3
4: Exhaust - To Follow	4
5: Engine Control	5
6: Clutch	6
7: Gearbox	7
8: Propshaft - To Follow	8
9: Rear Axle - To Follow	9
10: Front Axle	10
11: Wheels & Hubs	11
12: Suspension	12
13: Steering	13
14: Brakes	14
15: Cab & Body	15
16: Electrical	16

Suffix Key; OE = Original Equipment, R = Reconditioned Part
OEM = Original Equipment Manufacturer, ALT = Alternative Supplier Part

OE Numbers used for Cross Reference Purposes Only

sales@direct-sourcing-solutions.com www.direct-sourcing-solutions.com

Tel; +44 (0) 1653 668179 Fax; +44 (0) 1905 507755

General Information

This catalogue contains spare parts suitable for Renault Truck vehicles.

The first line contains the DSS Part Number, the second line, where applicable, shows the OE numbers and the following line **[in bold]** gives a brief description.

The following two lines relate to Vehicle Application, Individual Model Fitment, and also to assist in identification of the Engine, Gearbox or Rear Axle type.

The final line offers additional information to help with identification, with further qualification where possible using Engine or Chassis number.

Whilst every effort has been made to ensure all information in this catalogue is correct, we cannot accept any responsibility whatsoever for any errors found in this publication.

To further assist in identifying individual parts using whatever information may be available [Manufacturer / Supplier Part Number etc], why not check out the Direct Sourcing Solutions website and try our extensive Database Cross Reference Application.

Vehicle Type Description

The VIN (Vehicle Identification Number) consists of the following series of numbers and letters:

Example VIN no. VF611GTA000124463

VF6	= Manufacturer code (Renault Trucks)
11	= Series
G	= Axle combination
T	= Displacement
A0	= Chassis version
00124463	= Chassis number

Series:

11	= AE, AE Magnum, Magnum E-Tech
17	= Magnum DXi
22 / 24 / 25	= Premium
27	= Premium II
29	= Premium II DXi
33	= Kerax
34	= Kerax DXi
40	= Midliner
42 / 43 / 45 / 47	= Midlum
44	= Midlum DXi

Displacement:

C	=	6.2 litre
E	=	4.1 litre
G	=	5.0 litre / DXi
H	=	7.0 litre / DXi
K	=	13.0 litre / DXi
P	=	11.0 litre / DXi
S	=	12.0 litre / DXi
T	=	12.0 litre
V	=	11.0 litre
X	=	9.8 litre
Z	=	12.0 litre

Axle combination:

	Tractor-trailor rig	Flatbed
4x2	G	A
4x4	H	B
6x2	J	C
6x4	K	D
6x6	L	E
8x4	M	F
6x2/4	T	S

CAM Number Description

The CAM number specifies the vehicle date of manufacture.

Example: 30 D 3

30 = Consecutive day of month

D = Month

A	= January
B	= February
C	= March
D	= April
E	= May
F	= June
G	= July
H	= August
J	= September
K	= October
L	= November
M	= December

3 = Year

A	= 1980	T	= 1996
B	= 1981	V	= 1997
C	= 1982	W	= 1998
D	= 1983	X	= 1999
E	= 1984	Y	= 2000
F	= 1985	1	= 2001
G	= 1986	2	= 2002
H	= 1987	3	= 2003
J	= 1988	4	= 2004
K	= 1989	5	= 2005
L	= 1990	6	= 2006
M	= 1991	7	= 2007
N	= 1992	8	= 2008
P	= 1993	9	= 2009
R	= 1994	A	= 2010
S	= 1995	B	= 2011

Years Of Construction

C/CBH/CLM	1982 - 1998
M/S	1983 - 1996
ME/SE/CE	1996 - 2001
G	1982 - 1993
Manager	1991 - 1997
Maxter	1992 - 1997
R	1981 - 1990
Major	1990 - 1993
Midlum	2000 - 2005
Midlum II	2005 -
Midlum DXi	2006 -
Premium	1996 - 2005
Premium II	2005 -
Kerax	1996 - 2006
Kerax DXi	2006 -
AE	1990 - 1996
AE Magnum	1996 - 2000
Magnum E-Tech	2000 - 2005
Magnum DXi	2005 -

DSS Ltd do not have, or wish to imply any connection whatsoever with any Renault Truck Dealers / Manufacturers and / or their branding. Any part numbers are exclusively for reference purposes and do not indicate or imply any connection between DSS Ltd and any manufacturer and / or their parts / systems whatsoever. All data/contents contained within this publication copyright DSS Ltd 2014

E&OE

Direct Sourcing Solutions

Renault Catalogue 6.14.1

1: Engine Index



1

Big End Bearings	Pg: 16	Piston & Cylinder Liners	Pg: 13
Cylinder Head Gaskets	Pg: 5-6	Ring Gear	Pg: 18
Cylinder Liner Seals & O-Rings	Pg: 14	Rocker Cover Gaskets	Pg: 4
Engine Mountings	Pg: 22-23	Sump Gaskets & Seals	Pg: 7
Exhaust & Inlet Valves	Pg: 10	Sumps & Associated Parts	Pg: 20
Filters, Air	Pg: 1	Timing Gear Gaskets, Covers & Seals	Pg: 8
Filters, Fuel	Pg: 3	Turbochargers	Pg: 12
Filters, Oil	Pg: 2		
Flywheels & Bearings	Pg: 17		
Injector Sleeves & Seal Rings	Pg: 11		
Main Bearings	Pg: 15		
Oil Coolers, Gaskets & Associated Parts	Pg: 21		
Oil Filter Housing Gaskets	Pg: 9		
Oil Pumps & Repair Kits	Pg: 19		

Suffix Key; OE = Original Equipment, R = Reconditioned Part
OEM = Original Equipment Manufacturer, ALT = Alternative Supplier Part

OE Numbers used for Cross Reference Purposes Only

sales@direct-sourcing-solutions.com www.direct-sourcing-solutions.com

Tel; +44 (0) 1653 668179 Fax; +44 (0) 1905 507755

Direct Sourcing Solutions

Renault Catalogue 6.14.1

Section 1: Engine



Filters, Air

610005

5001865724

Air Filter

MIDLUM /DXi 5/7



610039

5001865723

Air Filter

MIDLUM DXi 5/7, PREMIUM II TR/PR/ DXi7, MAGNUM DXi 12/13



1

Suffix Key; OE = Original Equipment, R = Reconditioned Part

OEM = Original Equipment Manufacturer, ALT = Alternative Supplier Part

OE Numbers used for Cross Reference Purposes Only

sales@direct-sourcing-solutions.com www.direct-sourcing-solutions.com

Tel; +44 (0) 1653 668179 Fax; +44 (0) 1905 507755

Section: 1, Pg: 1

Direct Sourcing Solutions

Renault Catalogue 6.14.1

Section 1: Engine



1

Filters, Oil

610033

7420998807

Oil Filter - Paper Type

MIDLUM DXi 5/7, PREMIUM II DXi 7



610046

5001858001 5010412645 5010437356

Oil Spinner Filter, Centrifugal

PREMIUM TR/PR, KERAX, AE MAGNUM, MAGNUM E-TECH



610040

7420709459 7421561278

Oil Filter - Long Life

PREMIUM II TR/PR, KERAX /DXi 11/13, MAGNUM DXi 12/13



610041

7420541379 7421561284

Oil Filter - By Pass

PREMIUM II TR/PR, KERAX /DXi 11/13, MAGNUM DXi 12/13



Suffix Key; OE = Original Equipment, R = Reconditioned Part

OEM = Original Equipment Manufacturer, ALT = Alternative Supplier Part

OE Numbers used for Cross Reference Purposes Only

sales@direct-sourcing-solutions.com www.direct-sourcing-solutions.com

Tel; +44 (0) 1653 668179 Fax; +44 (0) 1905 507755

Section: 1, Pg: 2

Direct Sourcing Solutions

Renault Catalogue 6.14.1

Section 1: Engine



Filters, Fuel

630012

5001853860 5010450824 5010477855 5010505337

Fuel Filter

MIDLUM, PREMIUM TR/PR, KERAX, MAGNUM E-TECH, PUNCHER



1

630008

7421380472

Fuel/Water Separator Filter

PREMIUM II TR/PR, KERAX DXi 11/13, MAGNUM DXi 13



630009

7420875666 7420972291

Fuel Filter - Long Life

PREMIUM II TR/PR, KERAX /DXi 11/13, MAGNUM DXi 12/13

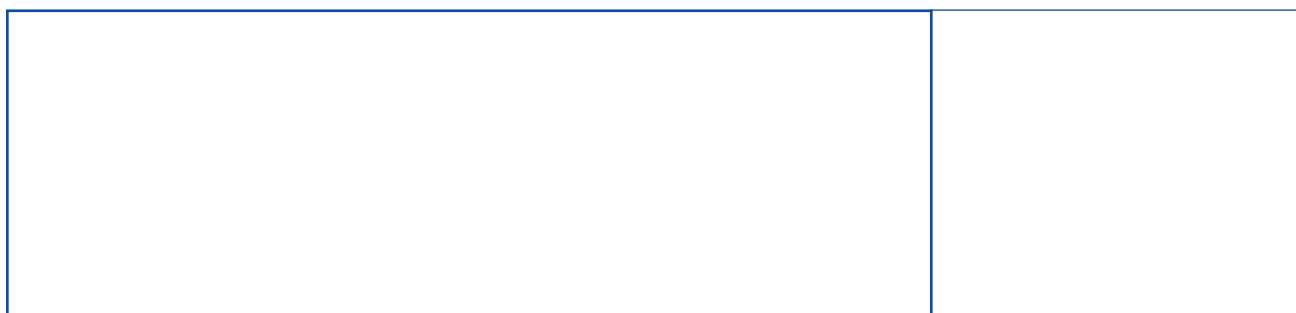
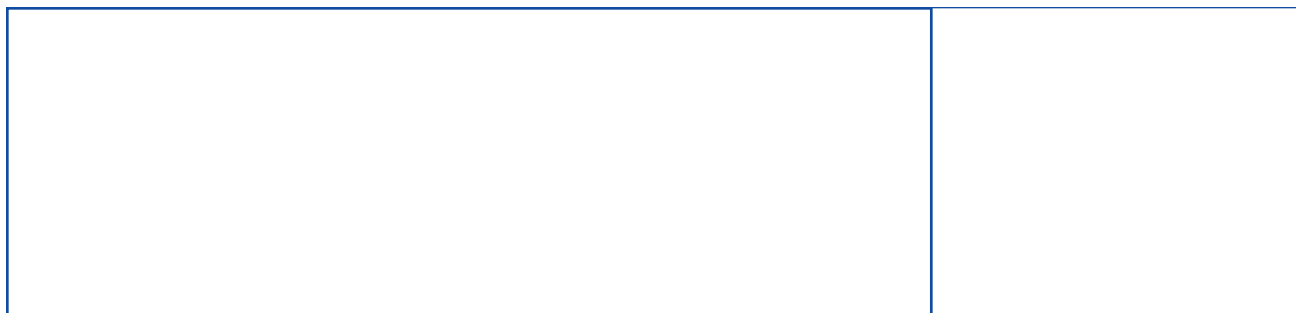

Suffix Key; OE = Original Equipment, R = Reconditioned Part

OEM = Original Equipment Manufacturer, ALT = Alternative Supplier Part

OE Numbers used for Cross Reference Purposes Only

sales@direct-sourcing-solutions.com www.direct-sourcing-solutions.com

Tel; +44 (0) 1653 668179 Fax; +44 (0) 1905 507755

Section: 1, Pg: 3



Rocker Cover Gaskets

1

610044

5010553654

Rocker Cover Gasket

MIDLUM, PREMIUM /PR, PUNCHER



610029

7420804638

Rocker Cover Gasket

PREMIUM II TR/PR, KERAX /DXi 11



610030

7420538793

Rocker Cover Gasket

KERAX DXi 13, MAGNUM DXi 13



610031

7421123014

Rocker Cover Gasket

MAGNUM DXi 12



Suffix Key; OE = Original Equipment, R = Reconditioned Part
OEM = Original Equipment Manufacturer, ALT = Alternative Supplier Part

OE Numbers used for Cross Reference Purposes Only



sales@direct-sourcing-solutions.com www.direct-sourcing-solutions.com

Tel; +44 (0) 1653 668179 Fax; +44 (0) 1905 507755

Section: 1, Pg: 4

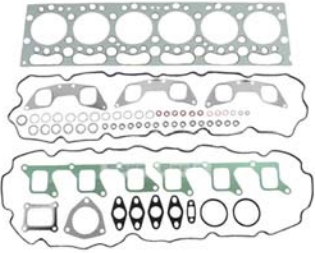
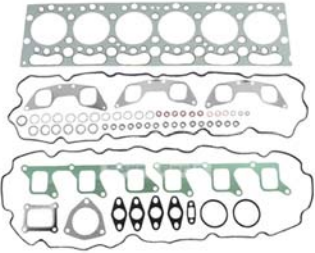

Cylinder Head Gaskets

<p>610051 5010477117 Cylinder Head Gasket PREMIUM /TR/PR, KERAX</p>	
<p>610052 5001857432 Cylinder Head Gasket Set PREMIUM /TR/PR, KERAX</p>	
<p>610054 5001866493 Cylinder Head Gasket Set PREMIUM TR DXi 11, PREMIUM PR DXi 11, KERAX DXi 11</p>	
<p>610048 7420495935 Cylinder Head Gasket PREMIUM II TR/ PR, KERAX /DXi 11</p>	
<p>610026 7420513037 Cylinder Head Gasket KERAX DXi 13, MAGNUM DXi 13</p>	

Suffix Key; OE = Original Equipment, R = Reconditioned Part

OEM = Original Equipment Manufacturer, ALT = Alternative Supplier Part

OE Numbers used for Cross Reference Purposes Only

sales@direct-sourcing-solutions.com www.direct-sourcing-solutions.com

Tel; +44 (0) 1653 668179 Fax; +44 (0) 1905 507755

Section: 1, Pg: 5

Direct Sourcing Solutions

Renault Catalogue 6.14.1

Section 1: Engine



Cylinder Head Gaskets

1

610027

7403099100

Cylinder Head Gasket

MAGNUM DXi 12

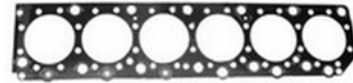

Suffix Key; OE = Original Equipment, R = Reconditioned Part

OEM = Original Equipment Manufacturer, ALT = Alternative Supplier Part

OE Numbers used for Cross Reference Purposes Only

sales@direct-sourcing-solutions.com www.direct-sourcing-solutions.com

Tel; +44 (0) 1653 668179 Fax; +44 (0) 1905 507755

Section: 1, Pg: 6





Direct Sourcing Solutions

Renault Catalogue 6.14.1

Section 1: Engine



Sump Gaskets & Seals

<p>610004 5010550818 Sump Gasket PREMIUM /TR/PR, KERAX</p>	
<p>610011 7420812484 74208148213 Sump Gasket PREMIUM II TR/PR, KERAX</p>	
<p>610012 7420532272 Sump Gasket MAGNUM DXi 12</p>	
<p>610013 7420541940 Sump Gasket MAGNUM DXi 13</p>	

1

Suffix Key; OE = Original Equipment, R = Reconditioned Part

OEM = Original Equipment Manufacturer, ALT = Alternative Supplier Part

OE Numbers used for Cross Reference Purposes Only

sales@direct-sourcing-solutions.com www.direct-sourcing-solutions.com

Tel; +44 (0) 1653 668179 Fax; +44 (0) 1905 507755

Section: 1, Pg: 7



Timing Gear Gaskets, Covers & Seals

610001

7420817742

Timing Case Seal Strip

PREMIUM II TR/PR, KERAX /DXi 11/13, MAGNUM DXi 13



610006

7420714247

Seal Strip - Lower Cam Gear Cover

MAGNUM DXi 12



610007

7420489341

Seal Strip - Cylinder Head > Timing Plate

MAGNUM DXi 12

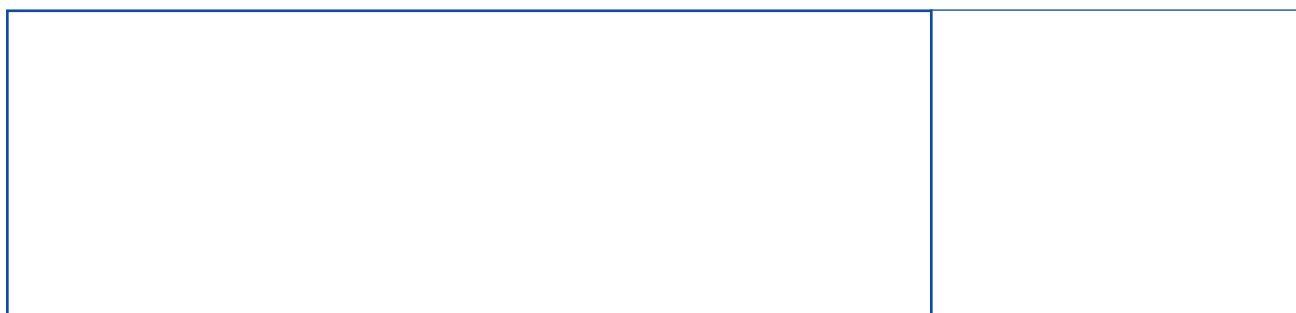
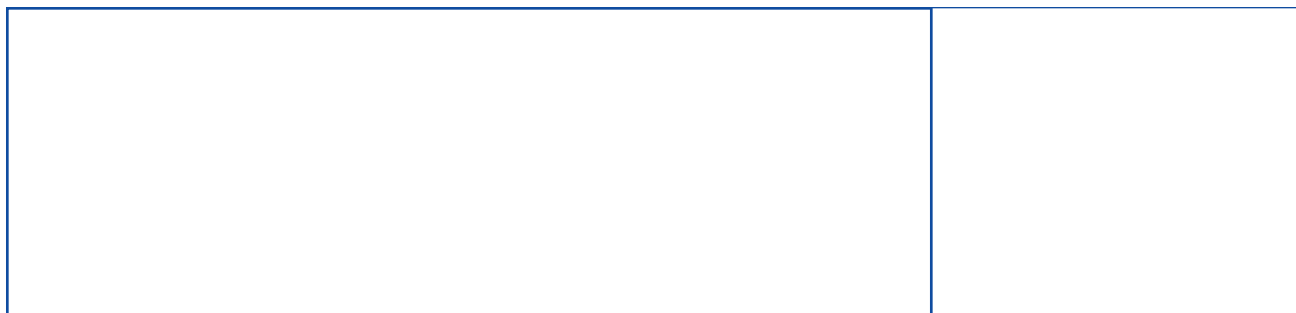

Suffix Key; OE = Original Equipment, R = Reconditioned Part
OEM = Original Equipment Manufacturer, ALT = Alternative Supplier Part

OE Numbers used for Cross Reference Purposes Only

sales@direct-sourcing-solutions.com www.direct-sourcing-solutions.com

Tel; +44 (0) 1653 668179 Fax; +44 (0) 1905 507755

Section: 1, Pg: 8



Direct Sourcing Solutions

Renault Catalogue 6.14.1

Section 1: Engine



Oil Filter Housing Gaskets

<p>610034 7420480827 Oil Filter Housing Gasket PREMIUM II TR/PR</p>	
<p>610035 7420787167 Oil Filter Housing Gasket KERAX DXi 13, MAGNUM DXi 13</p>	
<p>610036 7420510082 Oil Filter Housing Gasket MAGNUM DXi 12</p>	

1

Suffix Key; OE = Original Equipment, R = Reconditioned Part

OEM = Original Equipment Manufacturer, ALT = Alternative Supplier Part

OE Numbers used for Cross Reference Purposes Only

sales@direct-sourcing-solutions.com www.direct-sourcing-solutions.com

Tel; +44 (0) 1653 668179 Fax; +44 (0) 1905 507755

Section: 1, Pg: 9

Direct Sourcing Solutions

Renault Catalogue 6.14.1

Section 1: Engine



Exhaust & Inlet Valves

1

610024

7420459326

Inlet Valve

MAGNUM DXi 12



610025

7420441945

Exhaust Valve

MAGNUM DXi 12



Suffix Key; OE = Original Equipment, R = Reconditioned Part

OEM = Original Equipment Manufacturer, ALT = Alternative Supplier Part

OE Numbers used for Cross Reference Purposes Only

sales@direct-sourcing-solutions.com www.direct-sourcing-solutions.com

Tel; +44 (0) 1653 668179 Fax; +44 (0) 1905 507755

Section: 1, Pg: 10

Direct Sourcing Solutions

Renault Catalogue 6.14.1

Section 1: Engine



Injector Sleeves & Seal Rings

610028

7485104134

Injector Sleeve & O-Ring Kit

PREMIUM II TR/PR, KERAX /DXi 11/13, MAGNUM DXi 12/13



1

--	--

--	--

--	--

--	--

Suffix Key; OE = Original Equipment, R = Reconditioned Part

OEM = Original Equipment Manufacturer, ALT = Alternative Supplier Part

OE Numbers used for Cross Reference Purposes Only

sales@direct-sourcing-solutions.com www.direct-sourcing-solutions.com

Tel; +44 (0) 1653 668179 Fax; +44 (0) 1905 507755

Section: 1, Pg: 11

Direct Sourcing Solutions

Renault Catalogue 6.14.1

Section 1: Engine



Turbochargers

1

610032OEM

7420933086

Turbocharger

PREMIUM II TR/PR, KERAX DXi 11



--	--

--	--

--	--

--	--

Suffix Key; OE = Original Equipment, R = Reconditioned Part

OEM = Original Equipment Manufacturer, ALT = Alternative Supplier Part

OE Numbers used for Cross Reference Purposes Only

sales@direct-sourcing-solutions.com www.direct-sourcing-solutions.com

Tel; +44 (0) 1653 668179 Fax; +44 (0) 1905 507755

Section: 1, Pg: 12



Piston & Cylinder Liners

610021

7420515059

Piston & Liner Kit

MAGNUM DXi 12



1

--	--

--	--

--	--

--	--

Suffix Key; OE = Original Equipment, R = Reconditioned Part

OEM = Original Equipment Manufacturer, ALT = Alternative Supplier Part

OE Numbers used for Cross Reference Purposes Only

sales@direct-sourcing-solutions.com www.direct-sourcing-solutions.com

Tel; +44 (0) 1653 668179 Fax; +44 (0) 1905 507755

Section: 1, Pg: 13

Direct Sourcing Solutions

Renault Catalogue 6.14.1

Section 1: Engine



1

Cylinder Liner Seals & O-Rings

610022

7485103699

Cylinder Liner Seal Kit

PREMIUM II TR/PR, KERAX /DXi 11



610023

7400270950

Cylinder Liner Seal Kit

KERAX DXi 13, MAGNUM DXi 12/13

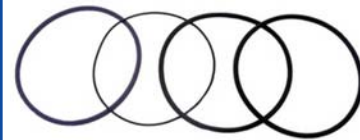

Suffix Key; OE = Original Equipment, R = Reconditioned Part

OEM = Original Equipment Manufacturer, ALT = Alternative Supplier Part

OE Numbers used for Cross Reference Purposes Only

sales@direct-sourcing-solutions.com www.direct-sourcing-solutions.com

Tel; +44 (0) 1653 668179 Fax; +44 (0) 1905 507755

Section: 1, Pg: 14

Direct Sourcing Solutions

Renault Catalogue 6.14.1

Section 1: Engine



Main Bearings

610016

7420867178

Main Bearing Set - (Set Of 7) STD

PREMIUM II TR/PR, KERAX /DXi 11



610017

7420530916

Main Bearing Set - (Set Of 7) STD

KERAX DXi 13, MAGNUM DXi 12/13



1

Suffix Key; OE = Original Equipment, R = Reconditioned Part

OEM = Original Equipment Manufacturer, ALT = Alternative Supplier Part

OE Numbers used for Cross Reference Purposes Only

sales@direct-sourcing-solutions.com www.direct-sourcing-solutions.com

Tel; +44 (0) 1653 668179 Fax; +44 (0) 1905 507755

Section: 1, Pg: 15

Direct Sourcing Solutions

Renault Catalogue 6.14.1

Section 1: Engine



Big End Bearings

1

610018

7400276134

Big End Bearing - (Set Of 6) STD

MAGNUM DXi 12



--	--

--	--

--	--

--	--

Suffix Key; OE = Original Equipment, R = Reconditioned Part

OEM = Original Equipment Manufacturer, ALT = Alternative Supplier Part

OE Numbers used for Cross Reference Purposes Only

sales@direct-sourcing-solutions.com www.direct-sourcing-solutions.com

Tel; +44 (0) 1653 668179 Fax; +44 (0) 1905 507755

Section: 1, Pg: 16

Direct Sourcing Solutions

Renault Catalogue 6.14.1

Section 1: Engine



Flywheels & Bearings

1

A Surcharge Will Be Levied If Old Unit Returned Is Not Of Reconditionable Standard

610047
5010550772
Flywheel
PREMIUM /TR/PR, KERAX



610019 **Alternatives; 610019R**
7420729327
Flywheel
MAGNUM DXi 12
Vehicles Fitted With 430mm Single Clutch, 235mm Drive Plate Damper Or 400mm Twin Clutch



Direct Sourcing Solutions

Renault Catalogue 6.14.1

Section 1: Engine



Ring Gear

1

610020

7420711957

Flywheel Ring Gear

PREMIUM II TR/PR, KERAX /DXi 11/13, MAGNUM DXi 12/13



--	--

--	--

--	--

--	--

Suffix Key; OE = Original Equipment, R = Reconditioned Part

OEM = Original Equipment Manufacturer, ALT = Alternative Supplier Part

OE Numbers used for Cross Reference Purposes Only

sales@direct-sourcing-solutions.com www.direct-sourcing-solutions.com

Tel; +44 (0) 1653 668179 Fax; +44 (0) 1905 507755

Section: 1, Pg: 18

Direct Sourcing Solutions

Renault Catalogue 6.14.1

Section 1: Engine



Oil Pumps & Repair Kits

610053

7420835230 7421736639

Oil Pump

PREMIUM /TR/PR, KERAX



1

Suffix Key; OE = Original Equipment, R = Reconditioned Part

OEM = Original Equipment Manufacturer, ALT = Alternative Supplier Part

OE Numbers used for Cross Reference Purposes Only

sales@direct-sourcing-solutions.com www.direct-sourcing-solutions.com

Tel; +44 (0) 1653 668179 Fax; +44 (0) 1905 507755

Section: 1, Pg: 19

Direct Sourcing Solutions

Renault Catalogue 6.14.1

Section 1: Engine



1

Sumps & Associated Parts

610055

7420801538

Engine Sump (Plastic)

KERAX

Use Sump Gasket 610056

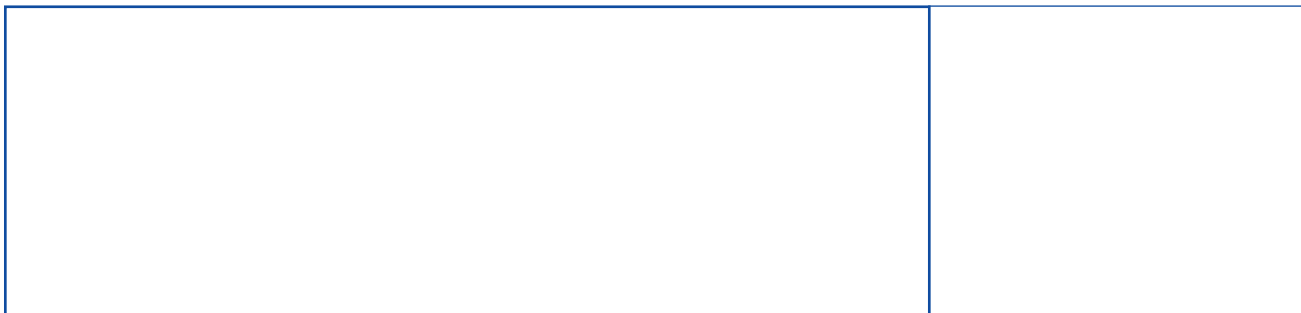
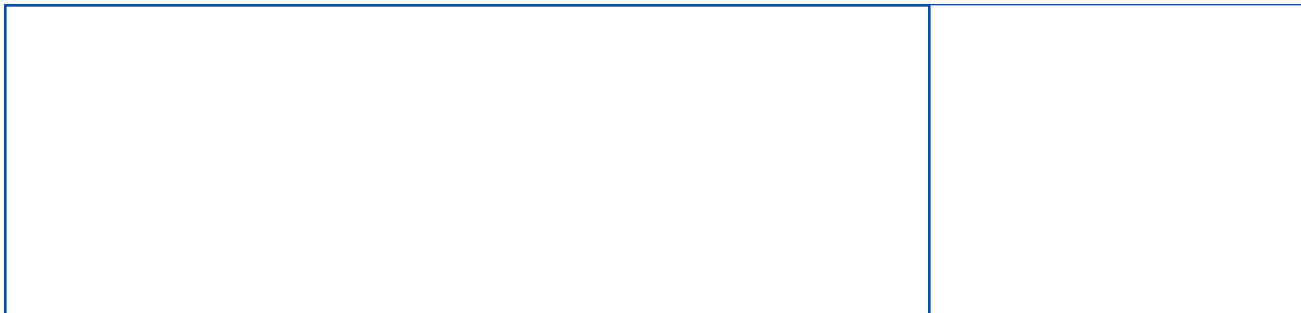
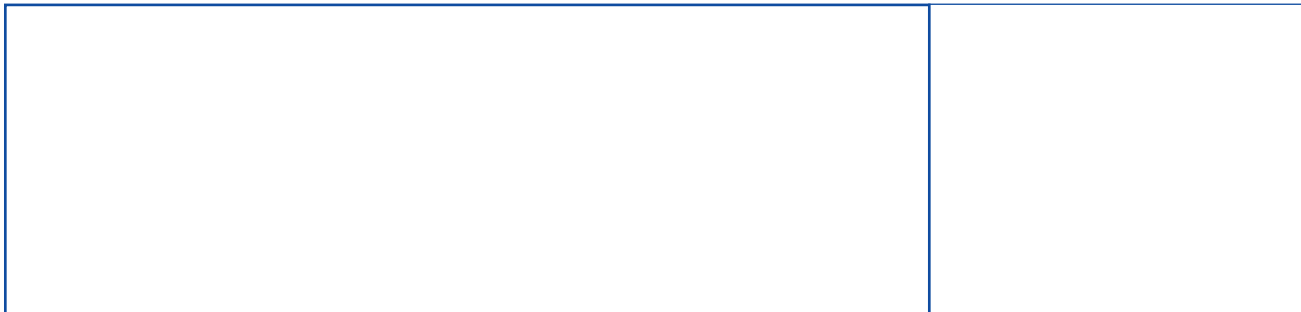

Suffix Key; OE = Original Equipment, R = Reconditioned Part

OEM = Original Equipment Manufacturer, ALT = Alternative Supplier Part

OE Numbers used for Cross Reference Purposes Only

sales@direct-sourcing-solutions.com www.direct-sourcing-solutions.com

Tel; +44 (0) 1653 668179 Fax; +44 (0) 1905 507755

Section: 1, Pg: 20



Oil Coolers, Gaskets & Associated Parts

<p>610010 7400471626 O-Ring, Side Plate PREMIUM II TR/PR, KERAX /DXi 11/13, MAGNUM DXi 13</p>	
<p>610008 7420979871 Oil Cooler Water Jacket Gasket KERAX DXi 13, MAGNUM DXi 13</p>	
<p>610009 7420712545 Oil Cooler Water Jacket Gasket MAGNUM DXi 12</p>	
<p>620017 7408130185 Gasket, Oil Cooler 4 Bolt Side Plate > Water Pipe MAGNUM DXi 12</p>	

Suffix Key; OE = Original Equipment, R = Reconditioned Part

OEM = Original Equipment Manufacturer, ALT = Alternative Supplier Part

OE Numbers used for Cross Reference Purposes Only

sales@direct-sourcing-solutions.com www.direct-sourcing-solutions.com

Tel; +44 (0) 1653 668179 Fax; +44 (0) 1905 507755

Section: 1, Pg: 21

Direct Sourcing Solutions

Renault Catalogue 6.14.1

Section 1: Engine



Engine Mountings

1

610042

5010316591

Engine Mounting, Front L/H

PREMIUM /TR/PR



610043

5010316592

Engine Mounting, Front R/H

PREMIUM /TR/PR



610049

5010460294

Engine Mounting, Front L/H

PREMIUM /TR/PR



610050

5010460295

Engine Mounting, Front R/H

PREMIUM /TR/PR



610037

7420503551

Engine Mounting, Front

KERAX DXi 13, MAGNUM DXi 12/13



Suffix Key; OE = Original Equipment, R = Reconditioned Part

OEM = Original Equipment Manufacturer, ALT = Alternative Supplier Part

OE Numbers used for Cross Reference Purposes Only

sales@direct-sourcing-solutions.com www.direct-sourcing-solutions.com

Tel; +44 (0) 1653 668179 Fax; +44 (0) 1905 507755

Section: 1, Pg: 22

Direct Sourcing Solutions

Renault Catalogue 6.14.1

Section 1: Engine



Engine Mountings

610038

7420499469

Engine Mounting, Rear

PREMIUM II TR/PR, KERAX /DXi 11, MAGNUM DXi 12/13



1

Suffix Key; OE = Original Equipment, R = Reconditioned Part

OEM = Original Equipment Manufacturer, ALT = Alternative Supplier Part

OE Numbers used for Cross Reference Purposes Only

sales@direct-sourcing-solutions.com www.direct-sourcing-solutions.com

Tel; +44 (0) 1653 668179 Fax; +44 (0) 1905 507755

Section: 1, Pg: 23

Direct Sourcing Solutions

Renault Catalogue 6.14.1

2: Cooling Index



2

Cooling Fans & Ancillary Parts	Pg: 6
Fan Belt Tensioners, Rollers & Bearings	Pg: 8-9
Fan Belts	Pg: 7
Fan Drives, Bearings & Seals	Pg: 11
Fan Pulleys & Bearings	Pg: 10
Intercoolers & Associated Parts	Pg: 2
Radiators	Pg: 1
Thermostats & Seals	Pg: 4-5
Water Pumps & Associated Parts	Pg: 3

Suffix Key; OE = Original Equipment, R = Reconditioned Part
OEM = Original Equipment Manufacturer, ALT = Alternative Supplier Part

OE Numbers used for Cross Reference Purposes Only

sales@direct-sourcing-solutions.com www.direct-sourcing-solutions.com

Tel; +44 (0) 1653 668179 Fax; +44 (0) 1905 507755



Radiators

620006

7420809775 5001868221

Radiator

MIDLUM DXi 5/7

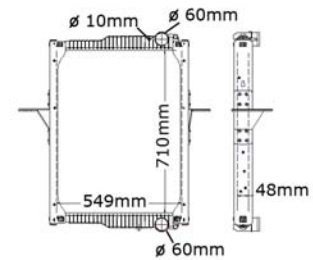

620001

5010315842

Radiator

PREMIUM /TR/PR

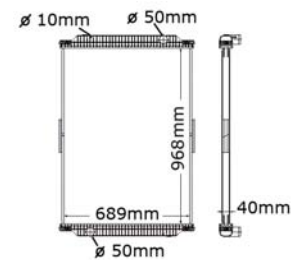

620002

5001839113 5001859152 5001859153 5001859154 5010315738

Radiator

PREMIUM /TR/PR

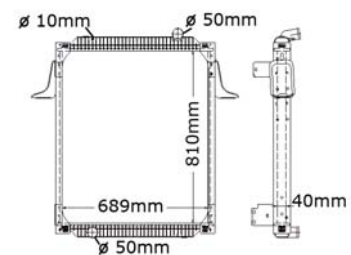

620007

5001867210 7420775792 7421699253

Radiator

PREMIUM II TR/PR

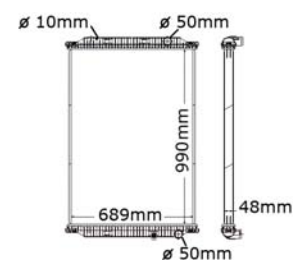

620036

50001868514 7420810095

Radiator

PREMIUM II DXi 7

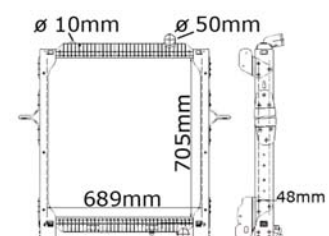

Suffix Key; OE = Original Equipment, R = Reconditioned Part

OEM = Original Equipment Manufacturer, ALT = Alternative Supplier Part

OE Numbers used for Cross Reference Purposes Only

sales@direct-sourcing-solutions.com www.direct-sourcing-solutions.com

Tel; +44 (0) 1653 668179 Fax; +44 (0) 1905 507755

Section: 2, Pg: 1



Intercoolers & Associated Parts

<p>620033 5001858491 5001858492 5001858493 5010315841 Intercooler PREMIUM /TR/PR</p>	
--	---

<p>620003 5001873718 5001873720 7482358714 Intercooler PREMIUM II TR/PR, MAGNUM DXi 12/13</p>	
---	---

--	--

--	--

--	--



Water Pumps & Associated Parts

<p>620004 5010550549 Water Pump PREMIUM</p>	
<p>620005 5001857427 5001858484 Water Pump PREMIUM /TR/PR, KERAX</p>	
<p>620009 5001866278 7420734268 Water Pump MAGNUM DXi 12</p>	
<p>620010 7420744939 7420744940 7485000963 Water Pump Without Pulley PREMIUM II TR/PR, KERAX /DXi 11/13, MAGNUM DXi 13</p>	
<p>620011 7420707160 7421617479 Water Pump Drive Pulley PREMIUM II TR/PR, KERAX /DXi 11</p>	

Suffix Key; OE = Original Equipment, R = Reconditioned Part

OEM = Original Equipment Manufacturer, ALT = Alternative Supplier Part

OE Numbers used for Cross Reference Purposes Only

sales@direct-sourcing-solutions.com www.direct-sourcing-solutions.com

Tel; +44 (0) 1653 668179 Fax; +44 (0) 1905 507755

Section: 2, Pg: 3

Direct Sourcing Solutions

Renault Catalogue 6.14.1

Section 2: Cooling



Thermostats & Seals

2

620021

7408149182

Thermostat 82 Degrees

MAGNUM DXi 12



620022

7401544710

Thermostat Seal

MAGNUM DXi 12

Gasket Sealing The Thermostat Housing To Cylinder Head



620018

7421237213

Thermostat 82 Degrees

PREMIUM II TR/PR, KERAX /DXi 11/13, MAGNUM DXi 13



620023

7420479636

Gasket - Coolant Pipe

PREMIUM II TR/PR, KERAX /DXi 11/13, MAGNUM DXi 13



620024

7408170519

Thermostat To Head Seal Gasket

MAGNUM DXi 12

Gasket Sealing The Thermostat Housing To Cylinder Head



Suffix Key; OE = Original Equipment, R = Reconditioned Part

OEM = Original Equipment Manufacturer, ALT = Alternative Supplier Part

OE Numbers used for Cross Reference Purposes Only

sales@direct-sourcing-solutions.com www.direct-sourcing-solutions.com

Tel; +44 (0) 1653 668179 Fax; +44 (0) 1905 507755

Section: 2, Pg: 4

Direct Sourcing Solutions

Renault Catalogue 6.14.1

Section 2: Cooling



Thermostats & Seals

620025

7408170514

Water Pipe To Pump Gasket - 2 Holes

MAGNUM DXi 12



620026

7408149301

Gasket - Top Hose Housing > Head

MAGNUM DXi 12

Gasket Sealing Top Hose Housing To Cylinder Head



Suffix Key; OE = Original Equipment, R = Reconditioned Part

OEM = Original Equipment Manufacturer, ALT = Alternative Supplier Part

OE Numbers used for Cross Reference Purposes Only

sales@direct-sourcing-solutions.com www.direct-sourcing-solutions.com

Tel; +44 (0) 1653 668179 Fax; +44 (0) 1905 507755

Section: 2, Pg: 5



Cooling Fans & Ancillary Parts

<p>620032 5010315994 Viscous Fan Hub PREMIUM /TR/PR, KERAX</p>	<p>Alternatives; 620032OEM</p> 
--	---

<p>620031 7420880406 7420993866 Viscous Fan Hub PREMIUM II TR/PR, KERAX /DXi 11</p>	
---	---

--	--

--	--

--	--

Direct Sourcing Solutions

Renault Catalogue 6.14.1

Section 2: Cooling



Fan Belts

Please Note: In Order To Identify The Correct Replacement Belt, It Is Advisable To Examine The Old Belt For Any OE Part Number, Or Similar References

620028

7420543481

Fan Drive Belt

PREMIUM, KERAX

8PK x 1520mm



620027

7420715585

Fan Drive Belt

MAGNUM DXi 12

8PK x 975mm



620029

7420725565

Fan Drive Belt

MAGNUM DXi 13

10PK x 1520mm

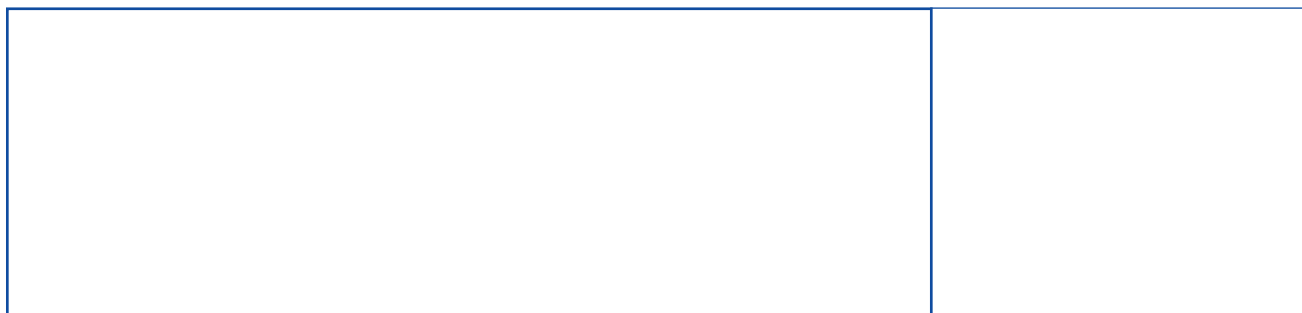

Suffix Key; OE = Original Equipment, R = Reconditioned Part
OEM = Original Equipment Manufacturer, ALT = Alternative Supplier Part

OE Numbers used for Cross Reference Purposes Only

sales@direct-sourcing-solutions.com www.direct-sourcing-solutions.com

Tel; +44 (0) 1653 668179 Fax; +44 (0) 1905 507755

Section: 2, Pg: 7



Fan Belt Tensioners, Rollers & Bearings

620013

5010550335 7403979980

Belt Tensioner Assembly

PREMIUM /TR/PR, KERAX



620014

7420739751 7420935521

Belt Tensioner Assembly

PREMIUM II TR/PR, KERAX /DXi 11/13, MAGNUM DXi 13

Early Version Has Plastic Roller, But Interchangeable



620016

7420487079

Belt Tensioner Assembly

KERAX DXi 13, MAGNUM DXi 13



620012

7408149855

Belt Tensioner

MAGNUM DXi 12



620015

7420521441 7421153968

Idler Pulley Assembly

KERAX DXi 13, MAGNUM DXi 13



Suffix Key; OE = Original Equipment, R = Reconditioned Part

OEM = Original Equipment Manufacturer, ALT = Alternative Supplier Part

OE Numbers used for Cross Reference Purposes Only

sales@direct-sourcing-solutions.com www.direct-sourcing-solutions.com

Tel; +44 (0) 1653 668179 Fax; +44 (0) 1905 507755

Section: 2, Pg: 8



Fan Belt Tensioners, Rollers & Bearings

620019

7420747516

Belt Tensioner Idler Roller

PREMIUM II TR/PR, KERAX DXi 11



2

620020

7408086970

Fan Belt Idler Roller, Grooved

PREMIUM II TR/PR, KERAX DXi 11

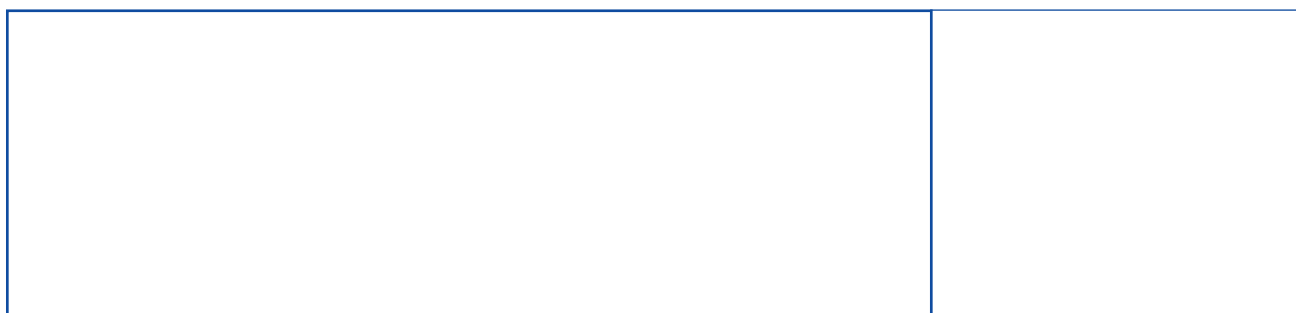
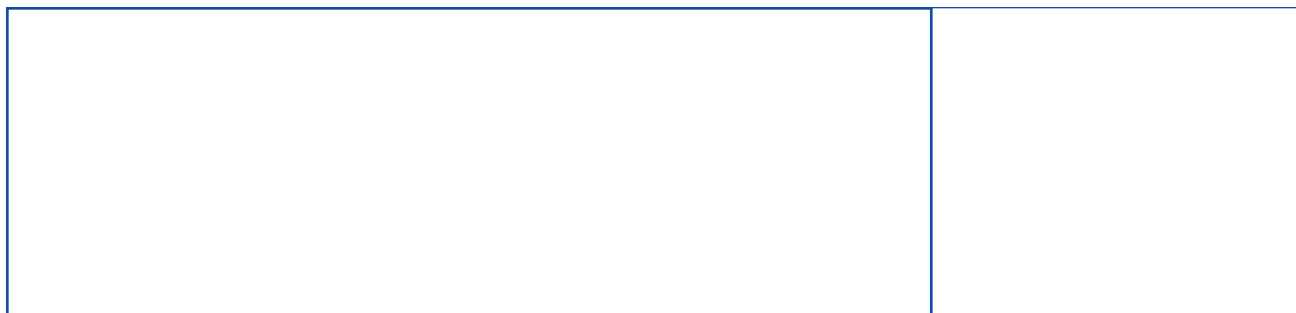
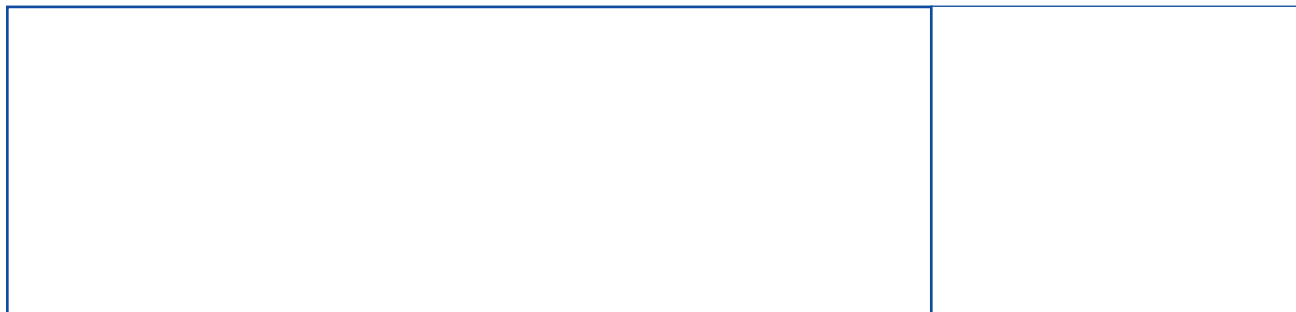

Suffix Key; OE = Original Equipment, R = Reconditioned Part

OEM = Original Equipment Manufacturer, ALT = Alternative Supplier Part

OE Numbers used for Cross Reference Purposes Only

sales@direct-sourcing-solutions.com www.direct-sourcing-solutions.com

Tel; +44 (0) 1653 668179 Fax; +44 (0) 1905 507755

Section: 2, Pg: 9

Direct Sourcing Solutions

Renault Catalogue 6.14.1

Section 2: Cooling



Fan Pulleys & Bearings

2

620034

7421146755 7420536568

Fan Pulley

PREMIUM II TR/PR, KERAX DXi 11



610014

7420838388

Fan Drive - Fan & Pump Drive Long & Short

PREMIUM II TR/PR, KERAX /DXi 11/13, MAGNUM DXi 13

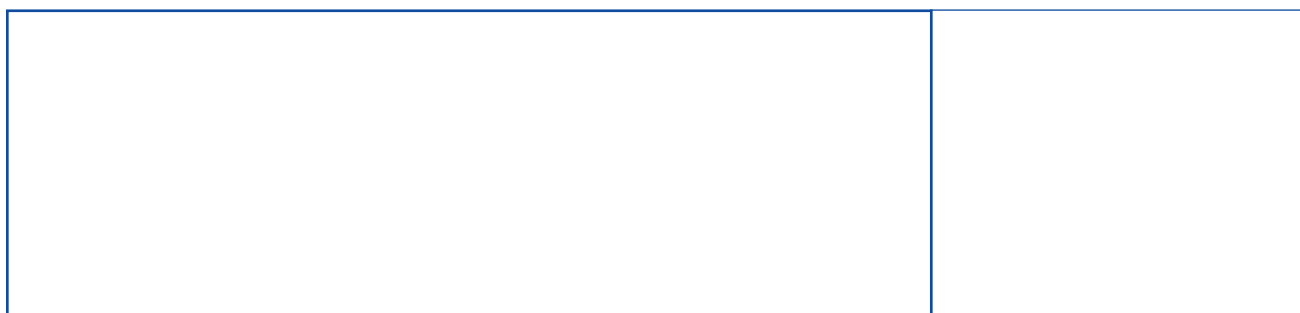
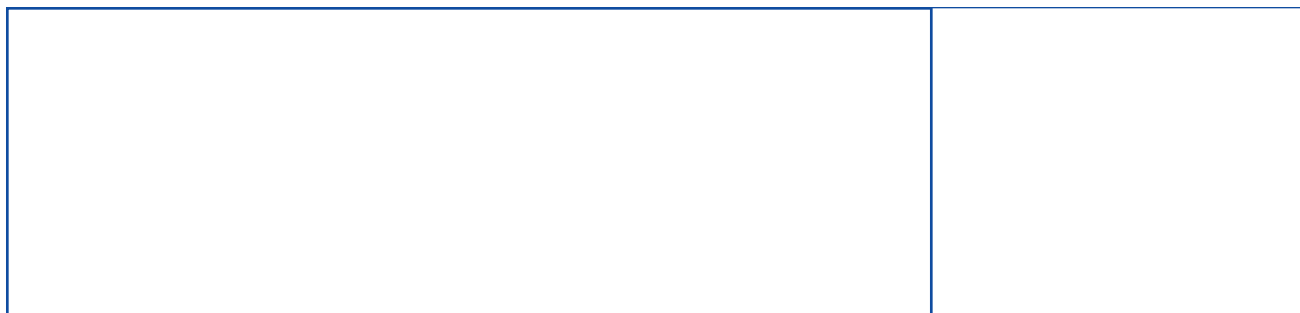
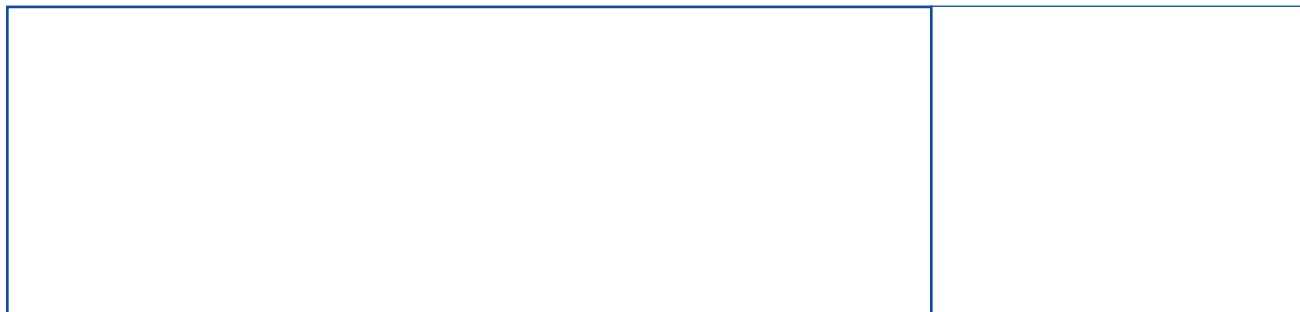

Suffix Key; OE = Original Equipment, R = Reconditioned Part

OEM = Original Equipment Manufacturer, ALT = Alternative Supplier Part

OE Numbers used for Cross Reference Purposes Only

sales@direct-sourcing-solutions.com www.direct-sourcing-solutions.com

Tel; +44 (0) 1653 668179 Fax; +44 (0) 1905 507755

Section: 2, Pg: 10

Direct Sourcing Solutions

Renault Catalogue 6.14.1

Section 2: Cooling



Fan Drives, Bearings & Seals

610015

7400011013

Fan Drive Bearing (Small)

KERAX DXi 13, MAGNUM DXi 13



2

Suffix Key; OE = Original Equipment, R = Reconditioned Part

OEM = Original Equipment Manufacturer, ALT = Alternative Supplier Part

OE Numbers used for Cross Reference Purposes Only

sales@direct-sourcing-solutions.com www.direct-sourcing-solutions.com

Tel; +44 (0) 1653 668179 Fax; +44 (0) 1905 507755

Section: 2, Pg: 11

Direct Sourcing Solutions

Renault Catalogue 6.14.1

3: Fuel Index



3

Common Rail Pumps & Associated Parts	Pg: 5
Filters, Fuel	Pg: 1
Fuel Injectors	Pg: 6
Fuel Tank Caps & Gaskets	Pg: 3
Fuel Tank Senders & Gauges	Pg: 2
Non Return Valves & Repair Kits	Pg: 4

Suffix Key; OE = Original Equipment, R = Reconditioned Part
OEM = Original Equipment Manufacturer, ALT = Alternative Supplier Part

OE Numbers used for Cross Reference Purposes Only

sales@direct-sourcing-solutions.com www.direct-sourcing-solutions.com

Tel; +44 (0) 1653 668179 Fax; +44 (0) 1905 507755

Direct Sourcing Solutions

Renault Catalogue 6.14.1

Section 3: Fuel



Filters, Fuel

630012

5001853860 5010450824 5010477855 5010505337

Fuel Filter

MIDLUM, PREMIUM TR/PR, KERAX, MAGNUM E-TECH, PUNCHER



630008

7421380472

Fuel/Water Separator Filter

PREMIUM II TR/PR, KERAX DXi 11/13, MAGNUM DXi 13



630009

7420875666 7420972291

Fuel Filter - Long Life

PREMIUM II TR/PR, KERAX /DXi 11/13, MAGNUM DXi 12/13

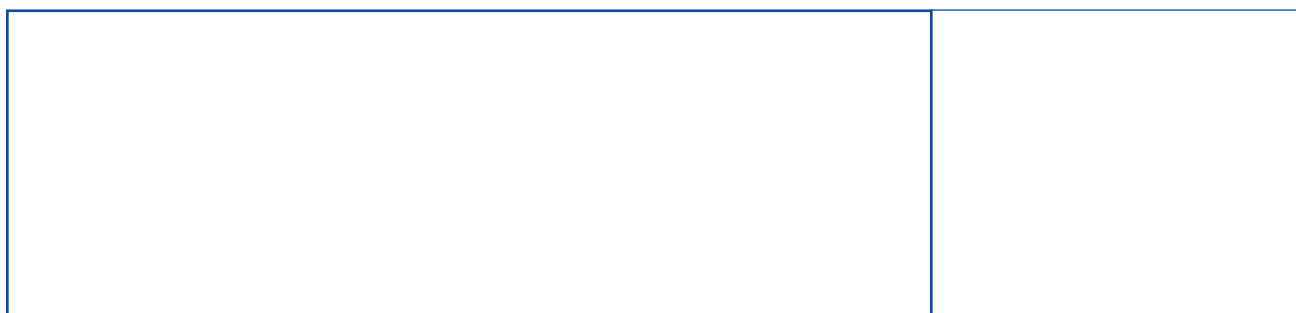
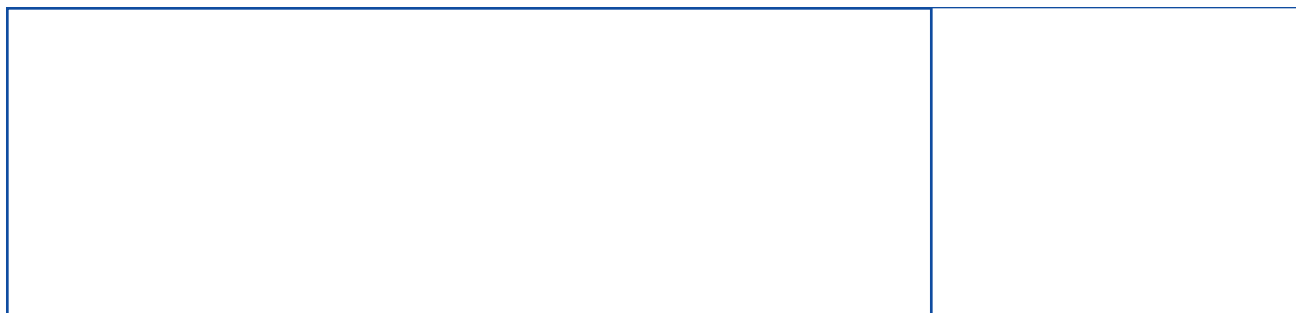

Suffix Key; OE = Original Equipment, R = Reconditioned Part
OEM = Original Equipment Manufacturer, ALT = Alternative Supplier Part

OE Numbers used for Cross Reference Purposes Only

sales@direct-sourcing-solutions.com www.direct-sourcing-solutions.com

Tel; +44 (0) 1653 668179 Fax; +44 (0) 1905 507755

Section: 3, Pg: 1



Fuel Tank Senders & Gauges

630011

7420981962 7482158841

Fuel Tank Sender

PREMIUM II TR/PR, KERAX /DXi 11/13, MAGNUM DXi 12/13

Length 690mm



Suffix Key; OE = Original Equipment, R = Reconditioned Part

OEM = Original Equipment Manufacturer, ALT = Alternative Supplier Part

OE Numbers used for Cross Reference Purposes Only

sales@direct-sourcing-solutions.com www.direct-sourcing-solutions.com

Tel; +44 (0) 1653 668179 Fax; +44 (0) 1905 507755

Section: 3, Pg: 2



Fuel Tank Caps & Gaskets

<p>630002 5001834430 5001864551 Fuel Tank Cap 80mm Side Key ALL MODELS</p>	



Non Return Valves & Repair Kits

630005

7420430101

Fuel Pump Non Return Valve

MAGNUM DXi 12

10mm Fitting Into Pump



630004

7420768698

Fuel Pump Repair Kit

MAGNUM DXi 12



Suffix Key; OE = Original Equipment, R = Reconditioned Part

OEM = Original Equipment Manufacturer, ALT = Alternative Supplier Part

OE Numbers used for Cross Reference Purposes Only



sales@direct-sourcing-solutions.com www.direct-sourcing-solutions.com

Tel; +44 (0) 1653 668179 Fax; +44 (0) 1905 507755

Section: 3, Pg: 4



Common Rail Pumps & Associated Parts

<p>630001 7420997341 7485103778 7421476011 Fuel Pump PREMIUM II TR/PR, KERAX /DXi 11/13, MAGNUM DXi 13</p>	
<p>630003 7403964833 Fuel Pump Gasket MAGNUM DXi 12</p>	

Suffix Key; OE = Original Equipment, R = Reconditioned Part

OEM = Original Equipment Manufacturer, ALT = Alternative Supplier Part

OE Numbers used for Cross Reference Purposes Only

sales@direct-sourcing-solutions.com www.direct-sourcing-solutions.com

Tel; +44 (0) 1653 668179 Fax; +44 (0) 1905 507755

Direct Sourcing Solutions

Renault Catalogue 6.14.1

Section 3: Fuel



Fuel Injectors

630013

7421340614

Service Exchange Injector - Delphi Type

KERAX DXi 13, MAGNUM DXi 13

4 Pin Plug



3

Suffix Key; OE = Original Equipment, R = Reconditioned Part

OEM = Original Equipment Manufacturer, ALT = Alternative Supplier Part

OE Numbers used for Cross Reference Purposes Only

sales@direct-sourcing-solutions.com www.direct-sourcing-solutions.com

Tel; +44 (0) 1653 668179 Fax; +44 (0) 1905 507755

Section: 3, Pg: 6

Direct Sourcing Solutions

Renault Catalogue 6.14.1



3

This Page Is Intentionally Left Blank

Suffix Key; OE = Original Equipment, R = Reconditioned Part
OEM = Original Equipment Manufacturer, ALT = Alternative Supplier Part

OE Numbers used for Cross Reference Purposes Only

sales@direct-sourcing-solutions.com www.direct-sourcing-solutions.com

Tel; +44 (0) 1653 668179 Fax; +44 (0) 1905 507755

Direct Sourcing Solutions

Renault Catalogue 6.14.1

5: Engine Control Index



Engine Sensors

Pg: 1-2

5

Suffix Key; OE = Original Equipment, R = Reconditioned Part
OEM = Original Equipment Manufacturer, ALT = Alternative Supplier Part

OE Numbers used for Cross Reference Purposes Only

sales@direct-sourcing-solutions.com www.direct-sourcing-solutions.com

Tel; +44 (0) 1653 668179 Fax; +44 (0) 1905 507755



Engine Sensors

<p>630007 7420706889 Turbocharger Boost Sensor MAGNUM DXi 12</p>	
<p>610002 Alternatives; 610002OEM 7420524936 Boost/Temperature Sensor MIDLUM DXi 5/7, PREMIUM II TR/PR/ DXi 7, KERAX DXi 11/13, MAGNUM DXi 12/13</p>	
<p>630010 5010412449 Crankshaft/Camshaft Sensor MIDLUM, PREMIUM /TR/PR, KERAX, PUNCHER</p>	
<p>680023 7420374282 Crankshaft/Camshaft Sensor MAGNUM DXi 12</p>	
<p>610045 7420796740 7420898038 7421302639 Oil Pressure Sensor MIDLUM DXi 5/7, PREMIUM II TR/PR/ DXi7, KERAX DXi 11/13, MAGNUM DXi 12/13 4 Pin Type</p>	



Engine Sensors

630006

7401077574

Oil Pressure Switch

PREMIUM II TR/PR, KERAX DXi 11/13, MAGNUM DXi 12/13

4 Pin Type



610003

7485116444 7420796744

Crankcase/Fuel Pressure Sensor

PREMIUM II TR/PR, KERAX/DXi 11/13, MAGNUM DXi 12/13

4 Pin Type



Suffix Key; OE = Original Equipment, R = Reconditioned Part

OEM = Original Equipment Manufacturer, ALT = Alternative Supplier Part

OE Numbers used for Cross Reference Purposes Only

sales@direct-sourcing-solutions.com www.direct-sourcing-solutions.com

Tel; +44 (0) 1653 668179 Fax; +44 (0) 1905 507755

Section: 5, Pg: 2

Direct Sourcing Solutions

Renault Catalogue 6.14.1



5

This Page Is Intentionally Left Blank

Suffix Key; OE = Original Equipment, R = Reconditioned Part
OEM = Original Equipment Manufacturer, ALT = Alternative Supplier Part

OE Numbers used for Cross Reference Purposes Only

sales@direct-sourcing-solutions.com www.direct-sourcing-solutions.com

Tel; +44 (0) 1653 668179 Fax; +44 (0) 1905 507755

Direct Sourcing Solutions

Renault Catalogue 6.14.1

6: Clutch Index



Clutch Forks & Associated Parts Pg: 2

Clutch Servos & Associated Parts Pg: 1

Clutches & Clutch Kits Pg: 3

Suffix Key; OE = Original Equipment, R = Reconditioned Part
OEM = Original Equipment Manufacturer, ALT = Alternative Supplier Part

OE Numbers used for Cross Reference Purposes Only

sales@direct-sourcing-solutions.com www.direct-sourcing-solutions.com

Tel; +44 (0) 1653 668179 Fax; +44 (0) 1905 507755



Clutch Forks & Associated Parts

640002

5010452528

Clutch Fork

PREMIUM /TP/PR, PREMIUM II TR/PR, KERAX /DXi 11/13, AE MAGNUM, MAGNUM E-TECH, MAGNUM DXi 12/13



640003

7420806212

Clutch Fork Pivot Bearing

MAGNUM DXi 12



640004

7403150319

Bush, Clutch Rod > Fork

PREMIUM II TR/PR, MAGNUM DXi 12



Suffix Key; OE = Original Equipment, R = Reconditioned Part

OEM = Original Equipment Manufacturer, ALT = Alternative Supplier Part

OE Numbers used for Cross Reference Purposes Only

sales@direct-sourcing-solutions.com www.direct-sourcing-solutions.com

Tel; +44 (0) 1653 668179 Fax; +44 (0) 1905 507755

Section: 6, Pg: 2



Clutches & Clutch Kits

640009

Clutch 362mm, Pull Type

MIDLUM DXi



640012

5001872322 5001872324

Clutch Kit 395mm, 1 3/4" Spline, Push Type

MIDLUM DXi 5/7, PREMIUM DXi 7



640010

5001850395

Clutch 400mm, Pull Type

MIDLUM, PREMIUM /PR



640011

5001854688 5001866891 5001867227

Clutch Kit 430mm, Pull Type

PREMIUM TR/PR, KERAX, MAGNUM E-TECH



Suffix Key; OE = Original Equipment, R = Reconditioned Part

OEM = Original Equipment Manufacturer, ALT = Alternative Supplier Part

OE Numbers used for Cross Reference Purposes Only

sales@direct-sourcing-solutions.com www.direct-sourcing-solutions.com

Tel; +44 (0) 1653 668179 Fax; +44 (0) 1905 507755

Section: 6, Pg: 3

Direct Sourcing Solutions

Renault Catalogue 6.14.1

7: Gearbox Index



Gearbox Gaskets & Seals Pg: 2

Oil Filters, Gaskets & Seals Pg: 1

Switches & Sensors Pg: 3

Suffix Key; OE = Original Equipment, R = Reconditioned Part
OEM = Original Equipment Manufacturer, ALT = Alternative Supplier Part

OE Numbers used for Cross Reference Purposes Only

sales@direct-sourcing-solutions.com www.direct-sourcing-solutions.com

Tel; +44 (0) 1653 668179 Fax; +44 (0) 1905 507755

Direct Sourcing Solutions

Renault Catalogue 6.14.1

Section 7: Gearbox



Oil Filters, Gaskets & Seals

<p>640007 7485108176 Gearbox Filter Element PREMIUM II TR/PR, MAGNUM DXi 12</p>	
<p>640005 7401652776 Oil Seal Output Shaft PREMIUM II TR/PR, MAGNUM DXi 12/13</p>	

Direct Sourcing Solutions

Renault Catalogue 6.14.1

Section 7: Gearbox



Gearbox Gaskets & Seals

640006

7408171137

Selector Housing Gasket

PREMIUM II TR/PR, KERAX DXi 11/13, MAGNUM DXi 12/13

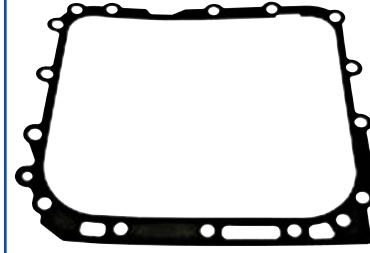

7

Suffix Key; OE = Original Equipment, R = Reconditioned Part

OEM = Original Equipment Manufacturer, ALT = Alternative Supplier Part

OE Numbers used for Cross Reference Purposes Only

sales@direct-sourcing-solutions.com www.direct-sourcing-solutions.com

Tel; +44 (0) 1653 668179 Fax; +44 (0) 1905 507755

Section: 7, Pg: 2



Switches & Sensors

640008

7420583477

Gearbox Impulse Sensor

PREMIUM II TR/PR, KERAX DXi 11/13, MAGNUM DXi 12/13



Suffix Key; OE = Original Equipment, R = Reconditioned Part

OEM = Original Equipment Manufacturer, ALT = Alternative Supplier Part

OE Numbers used for Cross Reference Purposes Only

sales@direct-sourcing-solutions.com www.direct-sourcing-solutions.com

Tel; +44 (0) 1653 668179 Fax; +44 (0) 1905 507755

Section: 7, Pg: 3

Direct Sourcing Solutions

Renault Catalogue 6.14.1

10: Front Axle Index



King Pin Kits & Associated Parts

Pg: 1-2

10

Suffix Key; OE = Original Equipment, R = Reconditioned Part
OEM = Original Equipment Manufacturer, ALT = Alternative Supplier Part

OE Numbers used for Cross Reference Purposes Only

sales@direct-sourcing-solutions.com www.direct-sourcing-solutions.com

Tel; +44 (0) 1653 668179 Fax; +44 (0) 1905 507755



King Pin Kits & Associated Parts

<p>670044 5010056002 5010630994 King Pin Kit (1 Side) MAXTER 6x4/8x4, PREMIUM 6x2/6x2/4>1999</p>	
<p>670007 5010630992 King Pin Kit M/S/ME/SE/CE, MIDLUM /DXi 5/7</p>	
<p>607397 5010630991 King Pin Kit Complete With Bearing MIDLUM /DXi 5/7</p>	
<p>650017 5010216742 5010630993 King Pin Kit MIDLUM /DXi 5/7, PREMIUM /TR/PR, AE MAGNUM, MAGNUM E-TECH, PUNCHER</p>	
<p>670004 7420590486 King Pin Kit PREMIUM II TR/PR/ DXi 7, KERAX /DXi 11/13, MAGNUM DXi 12/13</p>	

Suffix Key; OE = Original Equipment, R = Reconditioned Part

OEM = Original Equipment Manufacturer, ALT = Alternative Supplier Part

OE Numbers used for Cross Reference Purposes Only

sales@direct-sourcing-solutions.com www.direct-sourcing-solutions.com

Tel; +44 (0) 1653 668179 Fax; +44 (0) 1905 507755

Section: 10, Pg: 1



King Pin Kits & Associated Parts

670010

7403173772

King Pin Bearing

PREMIUM II TR/PR/ DXi 7, KERAX /DXi 11/13, MAGNUM DXi 12/13



Suffix Key; OE = Original Equipment, R = Reconditioned Part

OEM = Original Equipment Manufacturer, ALT = Alternative Supplier Part

OE Numbers used for Cross Reference Purposes Only

sales@direct-sourcing-solutions.com www.direct-sourcing-solutions.com

Tel; +44 (0) 1653 668179 Fax; +44 (0) 1905 507755

Section: 10, Pg: 2

Direct Sourcing Solutions

Renault Catalogue 6.14.1



This Page Is Intentionally Left Blank

10

Suffix Key; OE = Original Equipment, R = Reconditioned Part
OEM = Original Equipment Manufacturer, ALT = Alternative Supplier Part

OE Numbers used for Cross Reference Purposes Only

sales@direct-sourcing-solutions.com www.direct-sourcing-solutions.com

Tel; +44 (0) 1653 668179 Fax; +44 (0) 1905 507755

Direct Sourcing Solutions

Renault Catalogue 6.14.1

11: Wheels & Hubs Index



Hub Bearings, Front Axle	Pg: 4
Hub Bearings, Rear Axle	Pg: 5
Hub Lock Tabs, Nuts & Washers - Drive Axle	Pg: 8
Hub Nuts, Seals & Caps - Front, Push & Tag Axle	Pg: 6-7
Hubs, Front Axle	Pg: 1-2
Hubs, Rear Axle	Pg: 3
Wheel Nuts	Pg: 11
Wheel Studs, Metric	Pg: 9-10

Suffix Key; OE = Original Equipment, R = Reconditioned Part
OEM = Original Equipment Manufacturer, ALT = Alternative Supplier Part

OE Numbers used for Cross Reference Purposes Only

sales@direct-sourcing-solutions.com www.direct-sourcing-solutions.com

Tel; +44 (0) 1653 668179 Fax; +44 (0) 1905 507755



Hubs, Front Axle

650028

7485111789

Front Hub Complete With Bearing

PREMIUM, MAGNUM



650028NB

7485111789

Front Hub Without Bearing

PREMIUM, MAGNUM



650029

7485114470

Front Hub Complete With Bearing

PREMIUM, MAGNUM



650029NB

7485114470

Front Hub Without Bearing

PREMIUM, MAGNUM



650025

7421022433

Front Hub Complete With Bearing

PREMIUM PR/TR, PREMIUM DXi 7, MAGNUM DXi 12/13



Suffix Key; OE = Original Equipment, R = Reconditioned Part

OEM = Original Equipment Manufacturer, ALT = Alternative Supplier Part

OE Numbers used for Cross Reference Purposes Only

sales@direct-sourcing-solutions.com www.direct-sourcing-solutions.com

Tel; +44 (0) 1653 668179 Fax; +44 (0) 1905 507755

Section: 11, Pg: 1



Hubs, Front Axle

<p>650025NB 7421022433 Front Hub Without Bearing PREMIUM PR/TR, PREMIUM DXi 7, MAGNUM DXi 12/13</p>	
---	---

<p>670006 7421024160 7420534904 Front Hub Complete With Bearing PREMIUM II TR, KERAX DXi 11/13</p>	
--	---

<p>670006NB 7421024160 7420534904 Front Hub Without Bearing PREMIUM II TR, KERAX DXi 11/13</p>	
--	---

--	--

--	--



Hubs, Rear Axle

<p>650030 7421328181 Rear Hub Complete With Bearing PREMIUM II TR/PR/DXi 7, KERAX DXi 11/13 Tag Axle</p>	
--	---

<p>650005 7420535263 7485107753 Rear Hub Complete With Bearing PREMIUM II TR/PR/ DXi 7, MAGNUM DXi 12/13</p>	
--	---

<p>650005NB 7420535263 7485107753 Rear Hub Without Bearing PREMIUM II TR/PR/ DXi 7, MAGNUM DXi 12/13</p>	
--	---

--	--

--	--



Hub Bearings, Front Axle

<p>670001 Alternatives; 670001OEM</p> <p>7420518617 7421021381</p> <p>Front Wheel Bearing Kit 58mm</p> <p>PREMIUM II TR/PR DXi 7, MAGNUM DXi 12/13</p>	
--	--

<p>670002 Alternatives; 670002OEM</p> <p>7420518637 7421021391</p> <p>Front Wheel Bearing Kit 68mm</p> <p>PREMIUM II TR/PR DXi 7, KERAX DXi 11/13, MAGNUM DXi 12/13</p>	
---	--

<p>650007 Alternatives; 650007OEM</p> <p>5010439770</p> <p>Front Wheel Bearing Kit</p> <p>MIDLUM DXi 5/7, PREMIUM /TR/PR, KERAX, AE MAGNUM, MAGNUM E-TECH, PUNCHER</p>	
--	--

<p>650006OEM</p> <p>5010566154</p> <p>Front Wheel Bearing Kit</p> <p>PREMIUM, MAGNUM, KERAX</p>	
---	--

Empty space for additional information	Empty space for additional information
--	--



Hub Bearings, Rear Axle

670003

5001861915 7420518661 7420792439

Rear Wheel Bearing Kit 94mm

PREMIUM II TR/PR/ DXi 7, KERAX /DXi 11/13, MAGNUM DXi 12/13



--	--

--	--

--	--

--	--

Suffix Key; OE = Original Equipment, R = Reconditioned Part

OEM = Original Equipment Manufacturer, ALT = Alternative Supplier Part

OE Numbers used for Cross Reference Purposes Only

sales@direct-sourcing-solutions.com www.direct-sourcing-solutions.com

Tel; +44 (0) 1653 668179 Fax; +44 (0) 1905 507755

Section: 11, Pg: 5



Hub Nuts, Seals & Caps - Front, Push & Tag Axle

<p>670009 7403988672 7421302471 Front Hub Cap - Sealed Bearing 68mm PREMIUM II TR/PR/ DXi 7, KERAX DXi 11/13, MAGNUM DXi 12/13 Sealed Type Hub Bearing 68mm. Outer Edge Of Cap Has A Large Flange. Thread Diameter 120mm</p>	
<p>650027 5010571187 Hub Cap, Plastic MIDLUM</p>	
<p>650019 7420456099 Hub Nut 58mm Bearing PREMIUM TR/PR, MAGNUM DXi 12/13 Front, Push & Tag Axle</p>	
<p>650021 7420424593 Hub Lock Washer 58mm Bearing PREMIUM TR/PR, MAGNUM DXi 12/13 To Fit 650019</p>	
<p>650018 7420424598 Hub Nut 68mm Bearing PREMIUM TR/PR, MAGNUM DXi 12/13 Front & Tag Axle</p>	

Suffix Key; OE = Original Equipment, R = Reconditioned Part
OEM = Original Equipment Manufacturer, ALT = Alternative Supplier Part

OE Numbers used for Cross Reference Purposes Only

sales@direct-sourcing-solutions.com www.direct-sourcing-solutions.com

Tel; +44 (0) 1653 668179 Fax; +44 (0) 1905 507755

Section: 11, Pg: 6



Hub Nuts, Seals & Caps - Front, Push & Tag Axle

<p>650020 7401076701 Hub Lock Washer 68mm Bearing PREMIUM TR/PR, MAGNUM DXi 12/13 To Fit 650018</p>	



Hub Lock Tabs, Nuts & Washers - Drive Axle

<p>650010 7401076335 Hub Nut PREMIUM II TR/PR/ DXi 7, MAGNUM DXi 12/13</p>	





Wheel Studs, Metric

<p>650012 5010308911 Wheel Stud 46mm, Metric MIDLUM</p>	
<p>670015 7420515514 Wheel Stud Front 78mm, Disc Brake, Metric PREMIUM II TR/PR/ DXi 7, MAGNUM DXi 12/13</p>	
<p>670016 7420515515 Wheel Stud Front 88mm, Drum Brake, Metric PREMIUM II TR, KERAX DXi 11/13</p>	
<p>670011 7420515517 Wheel Stud Front/Rear 97mm, Metric MIDLUM DXi 5/7, PREMIUM II TR/PR/ DXi 7, KERAX DXi 11/13, MAGNUM DXi 12/13 Standard For Disc Brakes With Single Alloy Wheels</p>	
<p>670012 7420515518 Wheel Stud Front 100mm, Alloy Wheels, Metric PREMIUM II TR, KERAX DXi 11/13</p>	



Wheel Studs, Metric

<p>670013 7420515519 Wheel Stud Rear 105mm, Metric PREMIUM II TR/PR/ DXi 7, KERAX /DXi 11/13, MAGNUM DXi 12/13 10.9 M22 x 1.5 x 115/105. Standard For Disc And Drum Brakes With Twin Steel Wheels</p>	
---	---

<p>670014 7420524942 Wheel Stud Rear 114mm, Metric PREMIUM II TR/PR/ DXi 7, KERAX DXi 11/13, MAGNUM DXi 12/13 10.9 M22 x 1.5 x 124/114</p>	
--	---

--	--

--	--

--	--



Wheel Nuts

650016

5010262936

Wheel Nut, Metric

MIDLUM



670017

7420551045

Wheel Nut Front/Rear, Metric

MIDLUM, PREMIUM /TR/PR, PREMIUM II TR/PR, KERAX, MAGNUM DXi 12/13



Suffix Key; OE = Original Equipment, R = Reconditioned Part

OEM = Original Equipment Manufacturer, ALT = Alternative Supplier Part

OE Numbers used for Cross Reference Purposes Only

sales@direct-sourcing-solutions.com www.direct-sourcing-solutions.com

Tel; +44 (0) 1653 668179 Fax; +44 (0) 1905 507755

Section: 11, Pg: 11

Direct Sourcing Solutions

Renault Catalogue 6.14.1

12: Suspension Index



Air Springs	Pg: 7	V-Stay Repair Kits	Pg: 10
Air Suspension Valves, Switches & Sensors	Pg: 8	V-Stays	Pg: 9
Anti-Roll Bar Bushes, Front	Pg: 12		
Anti-Roll Bar Bushes, Rear	Pg: 14		
Anti-Roll Bar Link Rods, Front	Pg: 13		
Balance Beam & Associated Parts, Rear	Pg: 6		
Bump Stops, Front & Rear	Pg: 4		
Double Drive Bogie, Springs & Bolsters	Pg: 5		
Shock Absorbers, Front Axle	Pg: 15		
Shock Absorbers, Rear Axle	Pg: 16		
Spring Pins & Bushes, Front	Pg: 3		
Springs & Associated Parts, Front	Pg: 1		
Torque Rods & Repair Kits	Pg: 11		
U-Bolts & Nuts, Front	Pg: 2		

Suffix Key; OE = Original Equipment, R = Reconditioned Part
OEM = Original Equipment Manufacturer, ALT = Alternative Supplier Part

OE Numbers used for Cross Reference Purposes Only

sales@direct-sourcing-solutions.com www.direct-sourcing-solutions.com

Tel; +44 (0) 1653 668179 Fax; +44 (0) 1905 507755



Springs & Associated Parts, Front

<p>670039 5010557734 Front Spring, 2 Leaf PREMIUM II TR/PR/ DXi 7, KERAX DXi 11/13</p>	
--	--

<p>670045 5010557731 5010557732 Front Spring, 2 Leaf PREMIUM II TR/PR/ DXi 7, KERAX DXi 11, MAGNUM DXi 12/13</p>	
--	--

--	--

--	--

--	--



U-Bolts & Nuts, Front

<p>670035 5010488949 Front U-Bolt PREMIUM TR, PREMIUM II TR/PR/ DXi 7, MAGNUM E-TECH, MAGNUM DXi 12/13</p>	





Spring Pins & Bushes, Front

<p>670005 7420929989 Front Spring Bush PREMIUM II TR/PR, KERAX DXi 11, MAGNUM DXi 13</p>	



Bump Stops, Front & Rear

<p>670022 7400351111 Bump Stop, Front & Rear PREMIUM II TR/PR, KERAX DXi 11/13</p>	
--	---

<p>670018 7401506399 Bump Stop, 3 Section, Front & Rear Spring KERAX DXi 11/13</p>	
--	---



--	--

--	--

--	--



Double Drive Bogie, Springs & Bolsters

<p>670020 7420390836 Suspension Rubber PREMIUM II TR/PR, KERAX /DXi 11/13</p>	
<p>670019 7401629550 Suspension Rubber Retaining Plate PREMIUM II TR/PR, KERAX /DXi 11/13</p>	



Balance Beam & Associated Parts, Rear

<p>670021 7420442252 Rubber Bush Spring Saddle Double-Drive PREMIUM II TR/PR, KERAX /DXi 11/13</p>	

Direct Sourcing Solutions

Renault Catalogue 6.14.1

Section 12: Suspension



Air Springs

670037

5001855856 5010294546

Air Spring

PREMIUM, AE MAGNUM, MAGNUM E-TECH



670043

7420909153

Air Spring

PREMIUM II TR, MAGNUM DXi 12/13

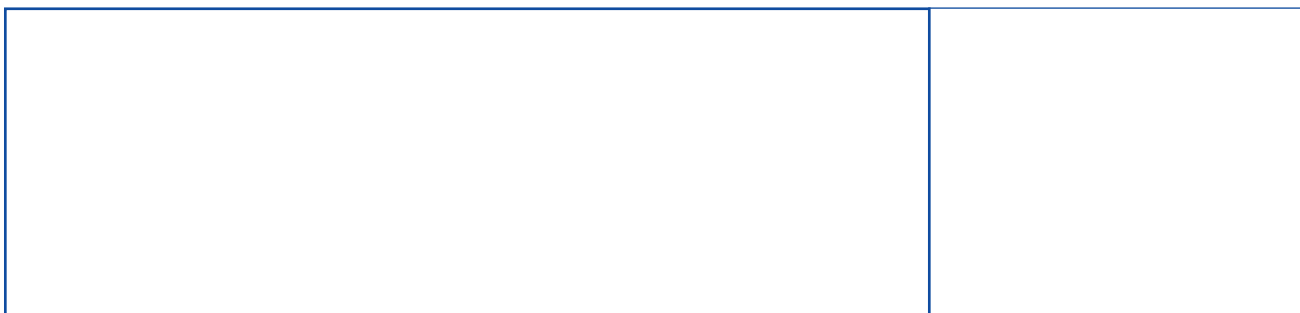
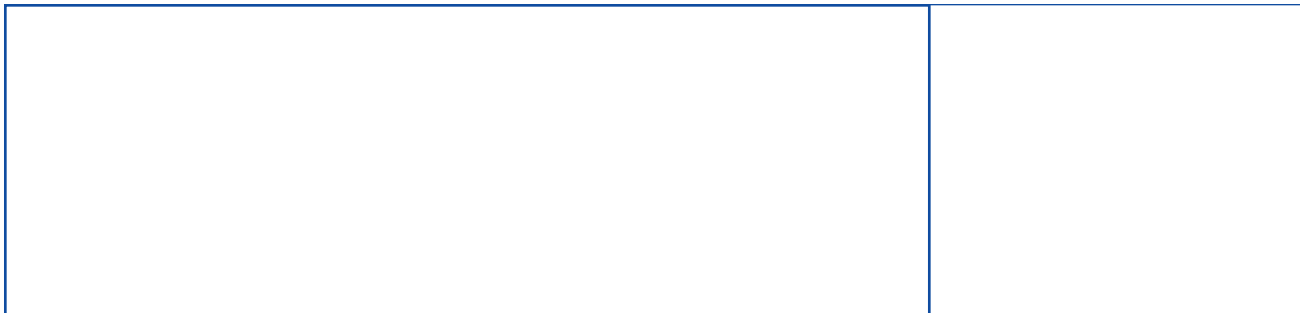
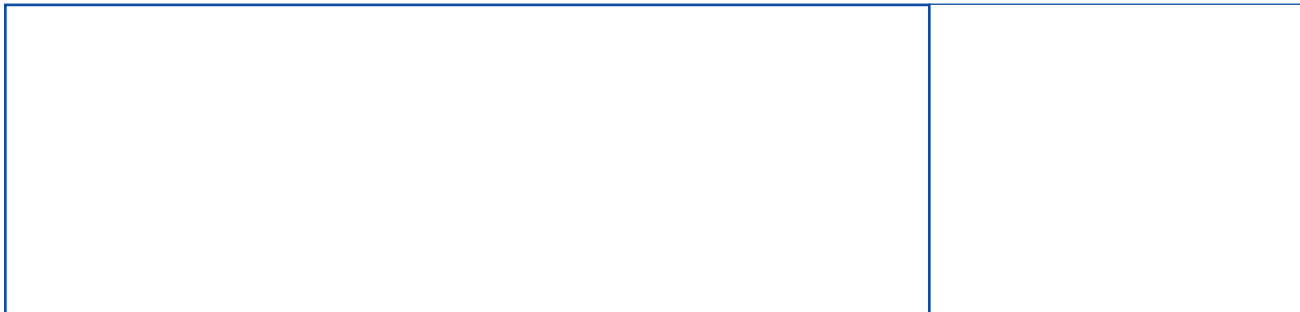

Suffix Key; OE = Original Equipment, R = Reconditioned Part

OEM = Original Equipment Manufacturer, ALT = Alternative Supplier Part

OE Numbers used for Cross Reference Purposes Only

sales@direct-sourcing-solutions.com www.direct-sourcing-solutions.com

Tel; +44 (0) 1653 668179 Fax; +44 (0) 1905 507755

Section: 12, Pg: 7



Air Suspension Valves, Switches & Sensors

<p>670034 7420850557 Ride Height Level Sensor MIDLUM DXi 5/7, PREMIUM II TR/PR/ DXi 7, MAGNUM DXi 12/13</p>	
---	---

<p>670008 7420514065 7420803650 Air Suspension Sensor Switch MIDLUM DXi 5/7, PREMIUM II TR/PR/ DXi 7, MAGNUM DXi 12/13</p>	
--	---

--	--

--	--

--	--

Direct Sourcing Solutions

Renault Catalogue 6.14.1

Section 12: Suspension



V-Stays

<p>670026 7420741703 V-Stay, Air Suspension PREMIUM II TR/PR/ DXi 7, KERAX DXi 11 Tube Length 475mm</p>	
---	---

<p>670023 7420829503 V-Stay, Heavy Duty Bogie KERAX DXi 11/13 58mm Bar 671mm Between Centres. Tube Length 490mm. No Removable Cap At Top Of Axle End Ball Joint</p>	
---	---

--	--

--	--

--	--





V-Stay Repair Kits

<p>670027 7420741710 V-Stay Axle Kit End PREMIUM II TR/PR/ DXi 7, KERAX DXi 11</p>	
<p>670028 7420547286 V-Stay Outer Repair Kit PREMIUM II TR/PR/ DXi 7, KERAX DXi 11</p>	
<p>670025 7420840815 V-Stay & Torque Rod Repair Kit KERAX DXi 11/13</p>	
<p>670024 7420840820 Centre Repair Kit, Steel Wheel KERAX DXi 11/13 Internal Diameter 90mm</p>	



Torque Rods & Repair Kits

<p>670029 7421051046 Torque Rod KERAX DXi 11/13</p>	
<p>670030 7420702096 Torque Rod Repair Kit KERAX DXi 11/13</p>	



Anti-Roll Bar Bushes, Front

<p>670032 7401134955 Anti-Roll Bar Eye Bush, Front, Internal Diameter 17mm PREMIUM II PR, KERAX /DXi 11/13 6x4 Silent Bush Type</p>	
<p>670041 5010383545 Anti-Roll Bar Bush, Front MIDLUM /DXi 5/7, PREMIUM /TR/PR, PREMIUM II TR/PR/ DXi 7, AE MAGNUM, MAGNUM E-TECH, MAGNUM DXi 12/13 20 x 51.3 x 60mm</p>	
<p>670040 5010130021 Anti-Roll Bar Bush, Front PREMIUM /TR/PR, AE, AE MAGNUM 38 x 68 x 60mm</p>	





Anti-Roll Bar Link Rods, Front

<p>670042 5010253255 Front Anti-Roll Bar Link Rod MIDLUM</p>	



Anti-Roll Bar Bushes, Rear

<p>670036 5010060356 Anti-Roll Bar Bush, Rear PREMIUM /TR/PR, PREMIUM II TR/PR/ DXi 7, KERAX, AE MAGNUM, MAGNUM E-TECH, MAGNUM DXi 12/13 4x2</p>	
<p>670033 7401629169 Anti-Roll Bar D Bush, Rear, 66mm Diameter PREMIUM II PR, KERAX /DXi 11/13 6x4</p>	



Shock Absorbers, Front Axle

<p>670038 5010630702 Shock Absorber, Front PREMIUM II TR/ DXi 7 Eye>Eye</p>	



Shock Absorbers, Rear Axle

670031

7420374543

Shock Absorber, Rear

PREMIUM II TR/ DXi 7

Eye>Pin



Suffix Key; OE = Original Equipment, R = Reconditioned Part

OEM = Original Equipment Manufacturer, ALT = Alternative Supplier Part

OE Numbers used for Cross Reference Purposes Only

sales@direct-sourcing-solutions.com www.direct-sourcing-solutions.com

Tel; +44 (0) 1653 668179 Fax; +44 (0) 1905 507755

Section: 12, Pg: 16

Direct Sourcing Solutions

Renault Catalogue 6.14.1



This Page Is Intentionally Left Blank

Suffix Key; OE = Original Equipment, R = Reconditioned Part
OEM = Original Equipment Manufacturer, ALT = Alternative Supplier Part

OE Numbers used for Cross Reference Purposes Only

sales@direct-sourcing-solutions.com www.direct-sourcing-solutions.com

Tel; +44 (0) 1653 668179 Fax; +44 (0) 1905 507755

Direct Sourcing Solutions

Renault Catalogue 6.14.1

13: Steering Index



Assister Ram & Ball Joints	Pg: 3
Draglink Ball Joints	Pg: 5
Draglinks	Pg: 4
Power Steering Pipe Work & Miscellaneous Parts	Pg: 2
Steering Pumps & O-Rings	Pg: 1
Track Rods	Pg: 6

Suffix Key; OE = Original Equipment, R = Reconditioned Part
OEM = Original Equipment Manufacturer, ALT = Alternative Supplier Part

OE Numbers used for Cross Reference Purposes Only

sales@direct-sourcing-solutions.com www.direct-sourcing-solutions.com

Tel; +44 (0) 1653 668179 Fax; +44 (0) 1905 507755





Steering Pumps & O-Rings

<p>650013 7403986328 Power Steering Pump ZF Type PREMIUM Single Steer Axle</p>	
<p>650026 5001865386 5010600046 Power Steering Pump PREMIUM /TR/PR, KERAX</p>	
<p>650008 5010600054 5001865396 Power Steering Pump PREMIUM /TR/PR, KERAX</p>	



Power Steering Pipe Work & Miscellaneous Parts

<p>650015 7420580233 Power Steering Oil Filter MIDLUM DXi 5/7, PREMIUM II TR/PR/ DXi 7, KERAX DXi 11, MAGNUM DXi 12/13 150mm Filter Length. Usually To Fit Twin Steer Vehicles</p>	
--	---

<p>650011 5000820895 Power Steering Oil Filter PREMIUM, PREMIUM II TR/PR, KERAX, KERAX DXi 11, AE MAGNUM, MAGNUM DXi 13</p>	
---	---

--	--

--	--

--	--



Assister Ram & Ball Joints

<p>650003 7403193731 Assister Ram Ball Joint PREMIUM</p>	
--	---

<p>650014 7403987648 Assister Ram Ball Joint, Rear Steer PREMIUM II PR/ DXi 7, MAGNUM DXi 13</p>	
--	---

--	--

--	--

--	--

Direct Sourcing Solutions

Renault Catalogue 6.14.1

Section 13: Steering



Draglinks

650022

5001868389 5010647032 5010647033

Draglink, Length 825mm

PREMIUM II TR/PR/ DXi 7



Suffix Key; OE = Original Equipment, R = Reconditioned Part

OEM = Original Equipment Manufacturer, ALT = Alternative Supplier Part

OE Numbers used for Cross Reference Purposes Only

sales@direct-sourcing-solutions.com www.direct-sourcing-solutions.com

Tel; +44 (0) 1653 668179 Fax; +44 (0) 1905 507755

Section: 13, Pg: 4



Draglink Ball Joints

<p>650024 5001867785 Draglink End RHT PREMIUM</p>	



Track Rods

650001

5010557341 5010488759 5010488639 5010488084

Track Rod, Length 918mm

MIDLUM /DXi 5/7



650004

5010587038

Track Rod (Fixed One End), Length 1686mm

PREMIUM II TR/PR/ DXi 7

Use Ball Joint 107447 And Adjuster Sleeve 207638



650023OEM

5010587004 5010600822 5010868363 7421560957

Track Rod (Cranked, Fixed One End), Length 1726mm

PREMIUM II PR/ DXi 7, MAGNUM DXi

Use Ball Joint 107447 And Adjuster Sleeve 207638



650002

5010439631 5001845518 5001869829 5010566090

Track Rod, Length 1752mm

KERAX



Suffix Key; OE = Original Equipment, R = Reconditioned Part

OEM = Original Equipment Manufacturer, ALT = Alternative Supplier Part

OE Numbers used for Cross Reference Purposes Only

sales@direct-sourcing-solutions.com www.direct-sourcing-solutions.com

Tel; +44 (0) 1653 668179 Fax; +44 (0) 1905 507755

Section: 13, Pg: 6

Direct Sourcing Solutions

Renault Catalogue 6.14.1



This Page Is Intentionally Left Blank

Suffix Key; OE = Original Equipment, R = Reconditioned Part
OEM = Original Equipment Manufacturer, ALT = Alternative Supplier Part

OE Numbers used for Cross Reference Purposes Only

sales@direct-sourcing-solutions.com www.direct-sourcing-solutions.com

Tel; +44 (0) 1653 668179 Fax; +44 (0) 1905 507755

Direct Sourcing Solutions

Renault Catalogue 6.14.1

14: Brakes Index



ABS Sensors & Associated Parts	Pg: 13
Air Dryer Filters, Desiccant & Repair Kits	Pg: 2
Back Plates	Pg: 10
Brake Chambers, Disc	Pg: 5
Brake Discs, Rear Axle	Pg: 6
Brake Drums, Rear	Pg: 9
Brake Pads	Pg: 11
Brake Shoe Return Spring & Pin	Pg: 8
Compressors & Repair Kits	Pg: 1
Load Sensing Valves	Pg: 4
Multi Circuit, Air Supply Valves & Distribution Manifolds	Pg: 3
Slack Adjusters	Pg: 12
Switches & Sensors	Pg: 14
Z Cam Auto Adjuster & Expander Parts	Pg: 7

Suffix Key; OE = Original Equipment, R = Reconditioned Part
OEM = Original Equipment Manufacturer, ALT = Alternative Supplier Part

OE Numbers used for Cross Reference Purposes Only

sales@direct-sourcing-solutions.com www.direct-sourcing-solutions.com

Tel; +44 (0) 1653 668179 Fax; +44 (0) 1905 507755

Direct Sourcing Solutions

Renault Catalogue 6.14.1

Section 14: Brakes



Compressors & Repair Kits

660005OEM

7421175029

Compressor

PREMIUM II TR/PR, KERAX /DXi 11/13, MAGNUM DXi 13



660006

7420713886 7485013125

Compressor

MAGNUM DXi 12

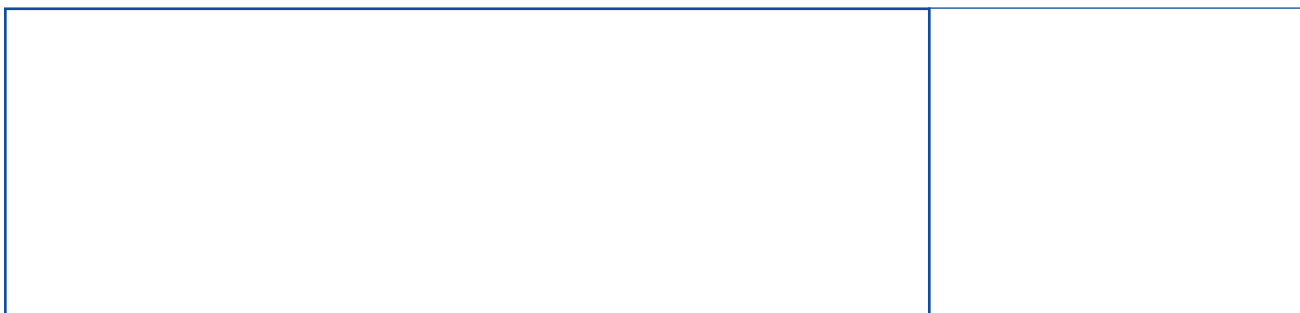
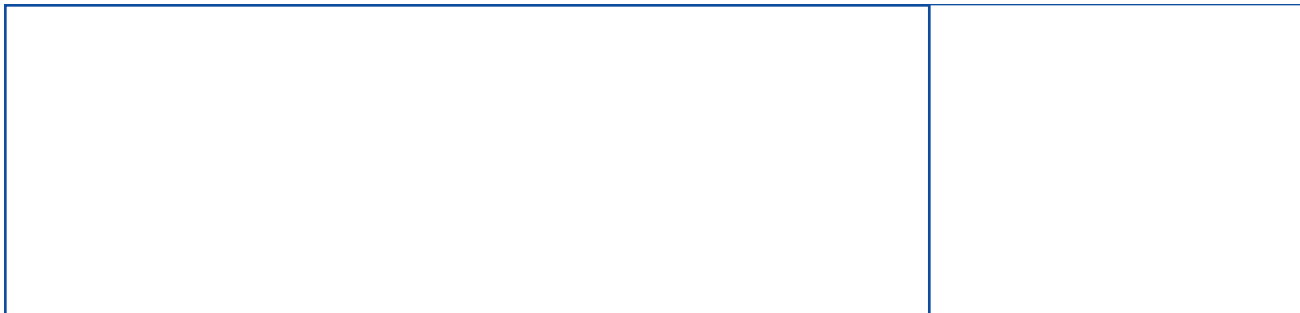
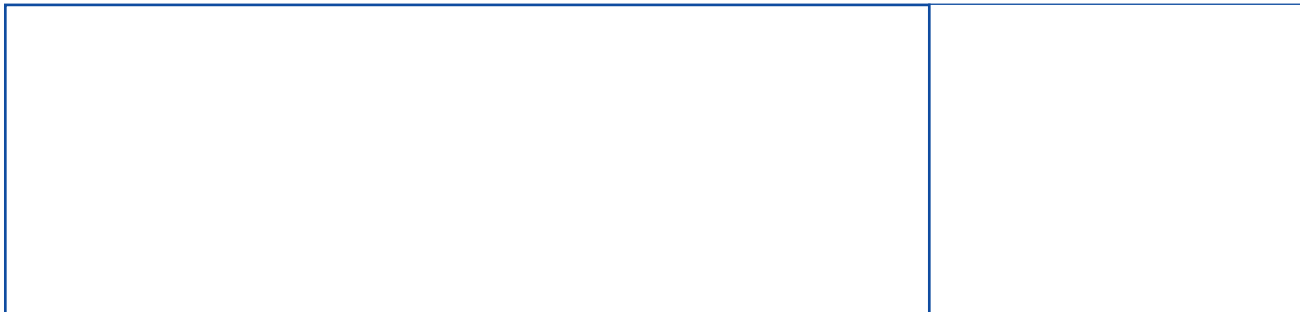

Suffix Key; OE = Original Equipment, R = Reconditioned Part
OEM = Original Equipment Manufacturer, ALT = Alternative Supplier Part

OE Numbers used for Cross Reference Purposes Only

sales@direct-sourcing-solutions.com www.direct-sourcing-solutions.com

Tel; +44 (0) 1653 668179 Fax; +44 (0) 1905 507755

Section: 14, Pg: 1



Air Dryer Filters, Desiccant & Repair Kits

<p>660016 5001830112 Air Dryer Cartridge MIDLUM, PREMIUM TR/PR, KERAX</p>	
<p>660018 7421602383 Air Dryer Filter MIDLUM DXi 5/7, PREMIUM II TR/PR, KERAX /DXi 11/13, MAGNUM DXi 12/13</p>	



Multi Circuit, Air Supply Valves & Distribution Manifolds

<p>660020 5001837079 5001837080 5001837081 5010216965 4 Way Multi Circuit Protection Valve 7 Port MIDLUM, PREMIUM /TR/PR, KERAX, AE, AE MAGNUM</p>	

Direct Sourcing Solutions

Renault Catalogue 6.14.1

Section 14: Brakes



Load Sensing Valves

<p>660003 5010260546 Load Sensing Valve PREMIUM</p>	<p>Alternatives; 660003OEM</p> 

Direct Sourcing Solutions

Renault Catalogue 6.14.1

Section 14: Brakes



Brake Chambers, Disc

<p>660004</p> <p>Brake Chamber Type 24/30 Disc Brake L/H & R/H PREMIUM</p>	



Brake Discs, Rear Axle

<p>660019 5010598306 Brake Disc Vented, Rear, 8 Hole MIDLUM, PREMIUM, MAGNUM, KERAX</p>	
<p>660022 5010598307 Brake Disc Vented, Rear, 375mm, 10 Hole MIDLUM, PREMIUM, MAGNUM, KERAX 8 Hole Disc</p>	
<p>660023 5010598309 Brake Disc Vented, Rear, 410mm, 10 Hole MIDLUM DXi 5/7</p>	
<p>660021 5010598304 Brake Disc Vented, Rear, 330mm, 6 Hole MIDLUM II DXi 5/7</p>	



Z Cam Auto Adjuster & Expander Parts

660012

5001868125

Driving Pinion L/H

PREMIUM II TR/PR/ DXi 7, KERAX /DXi 11/13
All Vehicles With Z Cam Brakes



660013

5001868126

Driving Pinion R/H

PREMIUM II TR/PR/ DXi 7, KERAX /DXi 11/13
All Vehicles With Z Cam Brakes



660014

5001868117

Z Cam Brake Expander Tappet L/H Thread

PREMIUM II TR/PR/ DXi 7, KERAX /DXi 11/13
All Vehicles With Z Cam Brakes



660015

5001868118

Z Cam Brake Expander Tappet R/H Thread

PREMIUM II TR/PR/ DXi 7, KERAX /DXi 11/13
All Vehicles With Z Cam Brakes



660010

7403090964

Adjuster Shaft Kit

PREMIUM II TR/PR, KERAX DXi 11/13
All Vehicles With Z Cam Brakes. Manual Adjuster And Retaining Sleeve Kit



Suffix Key; OE = Original Equipment, R = Reconditioned Part
OEM = Original Equipment Manufacturer, ALT = Alternative Supplier Part

OE Numbers used for Cross Reference Purposes Only

sales@direct-sourcing-solutions.com www.direct-sourcing-solutions.com

Tel; +44 (0) 1653 668179 Fax; +44 (0) 1905 507755

Section: 14, Pg: 7



Direct Sourcing Solutions

Renault Catalogue 6.14.1

Section 14: Brakes



Brake Shoe Return Spring & Pin

<p>660001 5010098945 Brake Shoe Return Spring PREMIUM /TR/PR, KERAX, AE, AE MAGNUM, MAGNUM E-TECH, PUNCHER</p>	
<p>660011 5001868113 Brake Shoe Return Spring Z Cam PREMIUM II TR/PR/ DXi 7, KERAX /DXi 11/13 All Vehicles With Z Cam Brakes</p>	

Direct Sourcing Solutions

Renault Catalogue 6.14.1

Section 14: Brakes



Brake Drums, Rear

<p>660026 5010098949 Brake Drum, Rear PREMIUM /TR/PR, KERAX, AE, AE MAGNUM, PUNCHER</p>	

Direct Sourcing Solutions

Renault Catalogue 6.14.1

Section 14: Brakes



Back Plates

660009

7420367343

Back Plate Z Cam 175mm

PREMIUM II TR/PR/ DXi 7, KERAX /DXi 11/13

All Vehicles With Z Cam Brakes. Back Plate Recess 50mm



660007

7401629835

Back Plate Z Cam 200mm

PREMIUM II TR/PR, KERAX /DXi 11/13

All Vehicles With Z Cam Brakes. Back Plate Recess 62.5mm



660008

7401629836

Back Plate Z Cam 225mm

PREMIUM II TR/PR/ DXi 7, KERAX DXi 11/13

All Vehicles With Z Cam Brakes. Back Plate Recess 76mm



Suffix Key; OE = Original Equipment, R = Reconditioned Part

OEM = Original Equipment Manufacturer, ALT = Alternative Supplier Part

OE Numbers used for Cross Reference Purposes Only

sales@direct-sourcing-solutions.com www.direct-sourcing-solutions.com

Tel; +44 (0) 1653 668179 Fax; +44 (0) 1905 507755

Section: 14, Pg: 10

Direct Sourcing Solutions

Renault Catalogue 6.14.1

Section 14: Brakes



Brake Pads

660027

5001864365 7421399915 7421496556

Brake Pad Set, Disc Brakes, Rear

MIDLUM DXi 5/7, PREMIUM II PR/DXi 7, MAGNUM DXi 12/13



660028

5001864380

Brake Pad Set, Disc Brakes

PREMIUM II TR, MAGNUM DXi 12/13

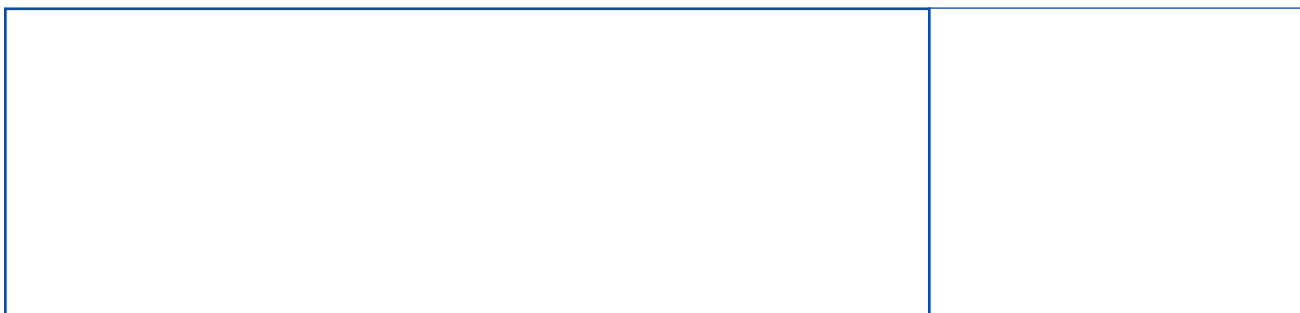
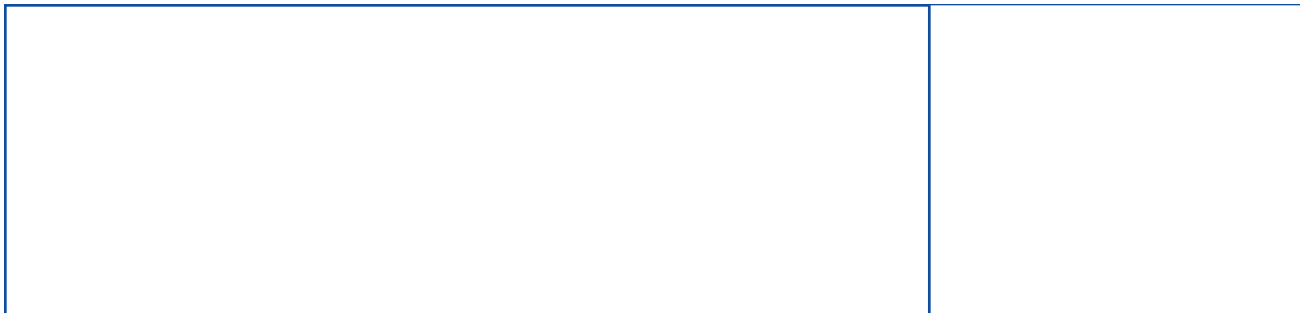
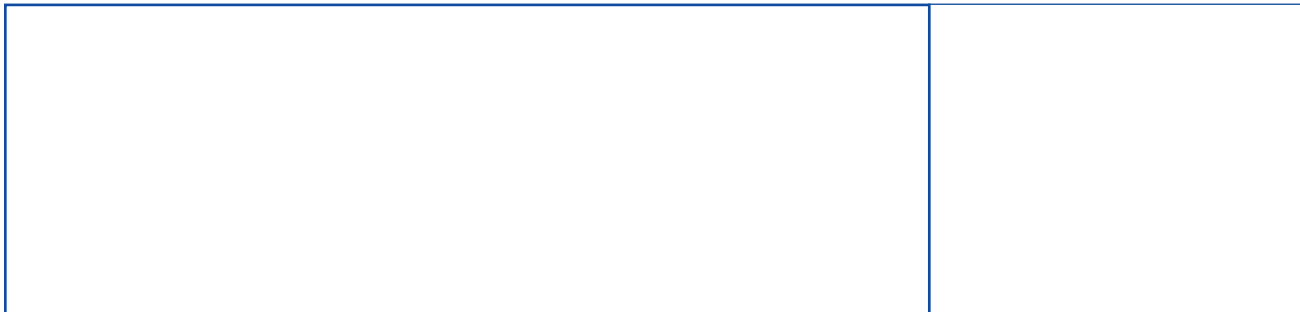
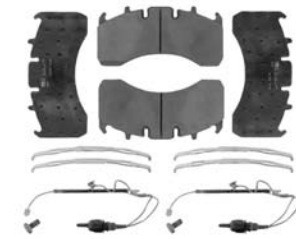

Suffix Key; OE = Original Equipment, R = Reconditioned Part

OEM = Original Equipment Manufacturer, ALT = Alternative Supplier Part

OE Numbers used for Cross Reference Purposes Only

sales@direct-sourcing-solutions.com www.direct-sourcing-solutions.com

Tel; +44 (0) 1653 668179 Fax; +44 (0) 1905 507755

Section: 14, Pg: 11

Direct Sourcing Solutions

Renault Catalogue 6.14.1

Section 14: Brakes



Slack Adjusters

660024

5010260028

Slack Adjuster - Rear L/H

PREMIUM /TR/PR, KERAX, AE MAGNUM, MAGNUM E-TECH, PUNCHER



660025

5010260027

Slack Adjuster - Rear R/H

PREMIUM /TR/PR, KERAX, AE MAGNUM, MAGNUM E-TECH, PUNCHER



Suffix Key; OE = Original Equipment, R = Reconditioned Part

OEM = Original Equipment Manufacturer, ALT = Alternative Supplier Part

OE Numbers used for Cross Reference Purposes Only



sales@direct-sourcing-solutions.com www.direct-sourcing-solutions.com

Tel; +44 (0) 1653 668179 Fax; +44 (0) 1905 507755

Section: 14, Pg: 12



ABS Sensors & Associated Parts

<p>660002 5010344188 ABS Sensor 1.4m PREMIUM /TR/PR, KERAX, AE MAGNUM, PUNCHER</p>	
<p>650009 7420424109 ABS Pulse Wheel Rear PREMIUM II TR/PR/ DXi 7, KERAX /DXi 11/13, MAGNUM DXi 12/13</p>	

Suffix Key; OE = Original Equipment, R = Reconditioned Part
OEM = Original Equipment Manufacturer, ALT = Alternative Supplier Part

OE Numbers used for Cross Reference Purposes Only

sales@direct-sourcing-solutions.com www.direct-sourcing-solutions.com

Tel; +44 (0) 1653 668179 Fax; +44 (0) 1905 507755

Section: 14, Pg: 13



Switches & Sensors

660017

7420803650

Air Pressure Sensor 0-12 Bar

MIDLUM DXi 5/7, PREMIUM II TR/PR/ DXi 7, MAGNUM DXi 12/13

Sensor For Air Bag Pressure



Suffix Key; OE = Original Equipment, R = Reconditioned Part

OEM = Original Equipment Manufacturer, ALT = Alternative Supplier Part

OE Numbers used for Cross Reference Purposes Only

sales@direct-sourcing-solutions.com www.direct-sourcing-solutions.com

Tel; +44 (0) 1653 668179 Fax; +44 (0) 1905 507755

Section: 14, Pg: 14

Direct Sourcing Solutions

Renault Catalogue 6.14.1



This Page Is Intentionally Left Blank

Suffix Key; OE = Original Equipment, R = Reconditioned Part
OEM = Original Equipment Manufacturer, ALT = Alternative Supplier Part

OE Numbers used for Cross Reference Purposes Only

sales@direct-sourcing-solutions.com www.direct-sourcing-solutions.com

Tel; +44 (0) 1653 668179 Fax; +44 (0) 1905 507755

Direct Sourcing Solutions

Renault Catalogue 6.14.1

15: Cab & Body Index



Body Panels, Doors & Ancillary Parts:		Rear Wings	Pg: 11-16
Midlum >2004	Pg: 1-2	Seats, Fittings & Associated Parts	Pg: 33-35
Premium	Pg: 3-4	Wipers & Associated Parts	Pg: 32
Premium II	Pg: 5-6		
Kerax	Pg: 7-8		
AE Magnum	Pg: 9-10		
Air Conditioning Compressors	Pg: 31		
Air Conditioning Radiators	Pg: 30		
Cab Air Bags	Pg: 26		
Cab Jack Rams	Pg: 29		
Cab Mountings	Pg: 25		
Cab Shock Absorbers	Pg: 27		
Cab Tilt Pumps	Pg: 28		
Mirrors	Pg: 17-24		

Suffix Key; OE = Original Equipment, R = Reconditioned Part
OEM = Original Equipment Manufacturer, ALT = Alternative Supplier Part

OE Numbers used for Cross Reference Purposes Only

sales@direct-sourcing-solutions.com www.direct-sourcing-solutions.com

Tel; +44 (0) 1653 668179 Fax; +44 (0) 1905 507755

Direct Sourcing Solutions

Renault Catalogue 6.14.1



Section 15: Cab & Body Continued Overleaf

Suffix Key; OE = Original Equipment, R = Reconditioned Part
OEM = Original Equipment Manufacturer, ALT = Alternative Supplier Part

OE Numbers used for Cross Reference Purposes Only

sales@direct-sourcing-solutions.com www.direct-sourcing-solutions.com

Tel; +44 (0) 1653 668179 Fax; +44 (0) 1905 507755

Renault Midlum >2004

www.direct-sourcing-solutions.com
Section: 15, Pg: 1

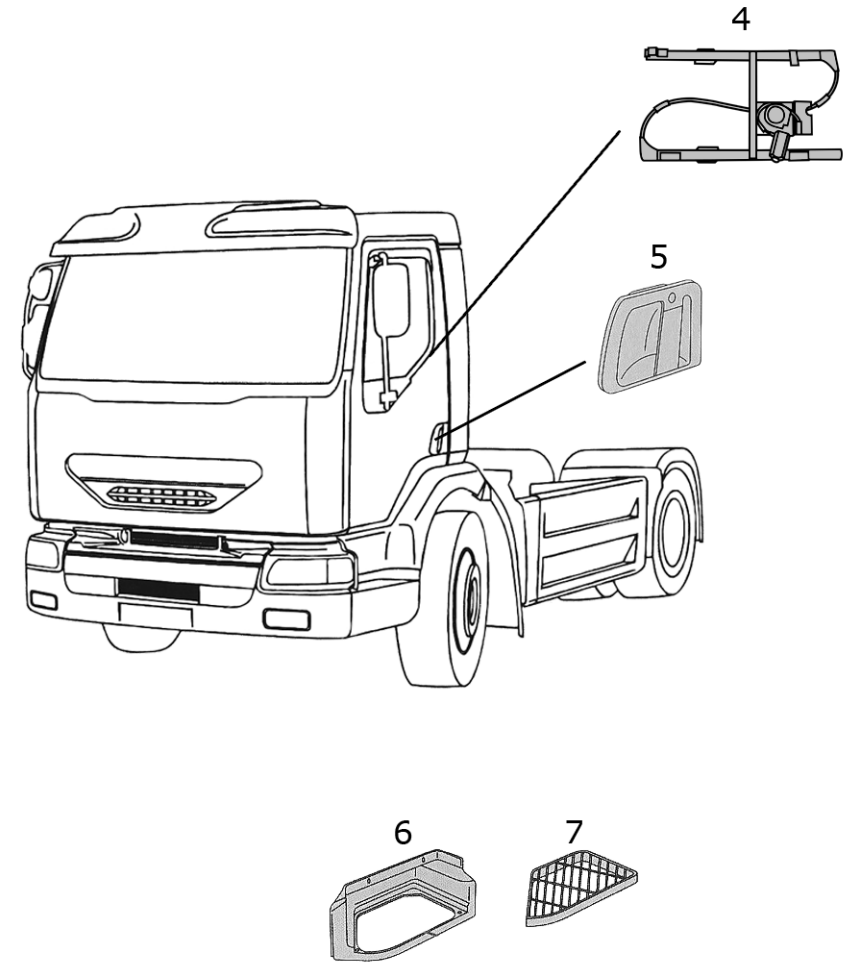
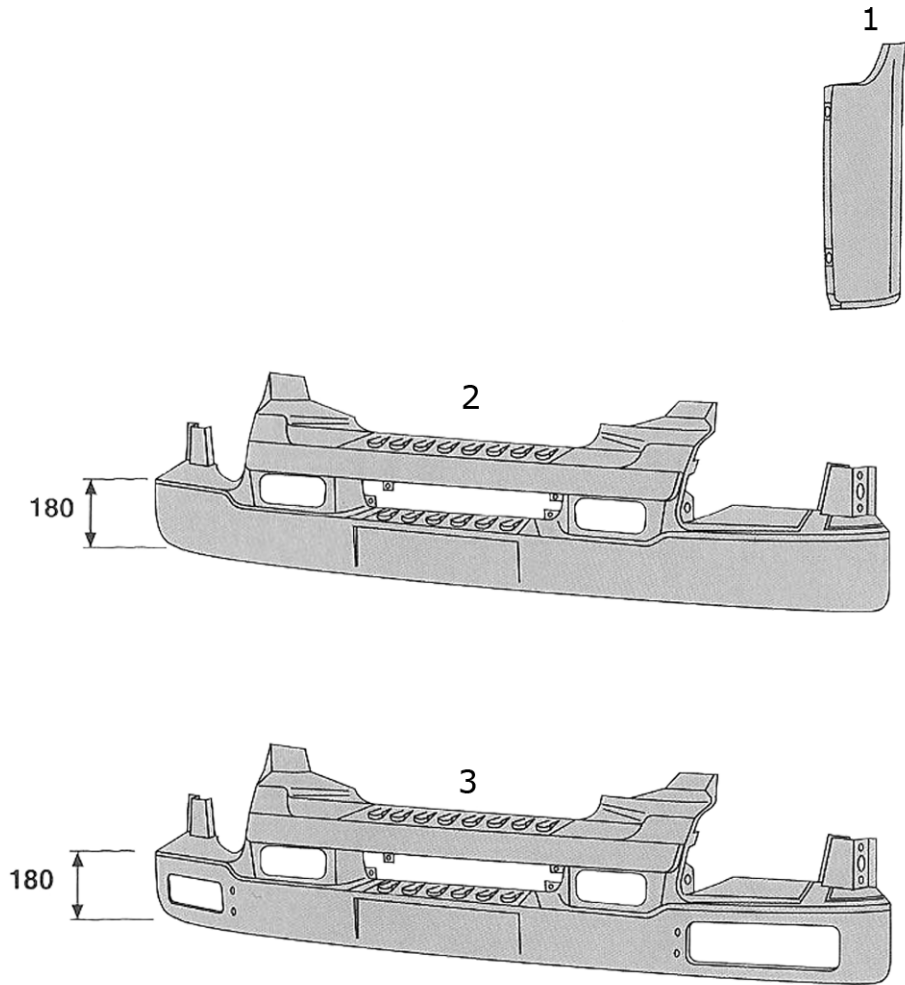



Section: 15, Pg: 2

1	690022	Corner Panel L/H 5010353331
1	690023	Corner Panel R/H 5010353330
2	609096	Front Bumper Without Holes For Fog Light 5010544309
3	609095	Front Bumper With Holes For Fog Light 5010544308
4	690010	Window Regulator L/H 5010301993
4	690009	Window Regulator R/H 5010301994 74824971947
5	609042	Door Handle L/H 5001858129
5	609041	Door Handle R/H 5001836268 5001858130
6	609069	Footstep Well Cover L/H 5010353495
6	609068	Footstep Well Cover R/H 5010353496
7	609009	Lower Footstep Grille (Plastic) L/H 5010544026
7	609008	Lower Footstep Grille (Plastic) R/H 5010544027
7	690004	Lower Footstep Grille (Aluminium) L/H & R/H 5010225398

Suffix Key; OE = Original Equipment, R = Reconditioned Equipment OEM = Original Equipment Manufacturer, ALT = Alternative Supplier Part

OE Numbers used for Cross Referencing Purposes Only

sales@direct-sourcing-solutions.com www.direct-sourcing-solutions.com

Tel; +44 (0) 1653 668179 Fax; +44 (0) 1905 507755

Renault Premium

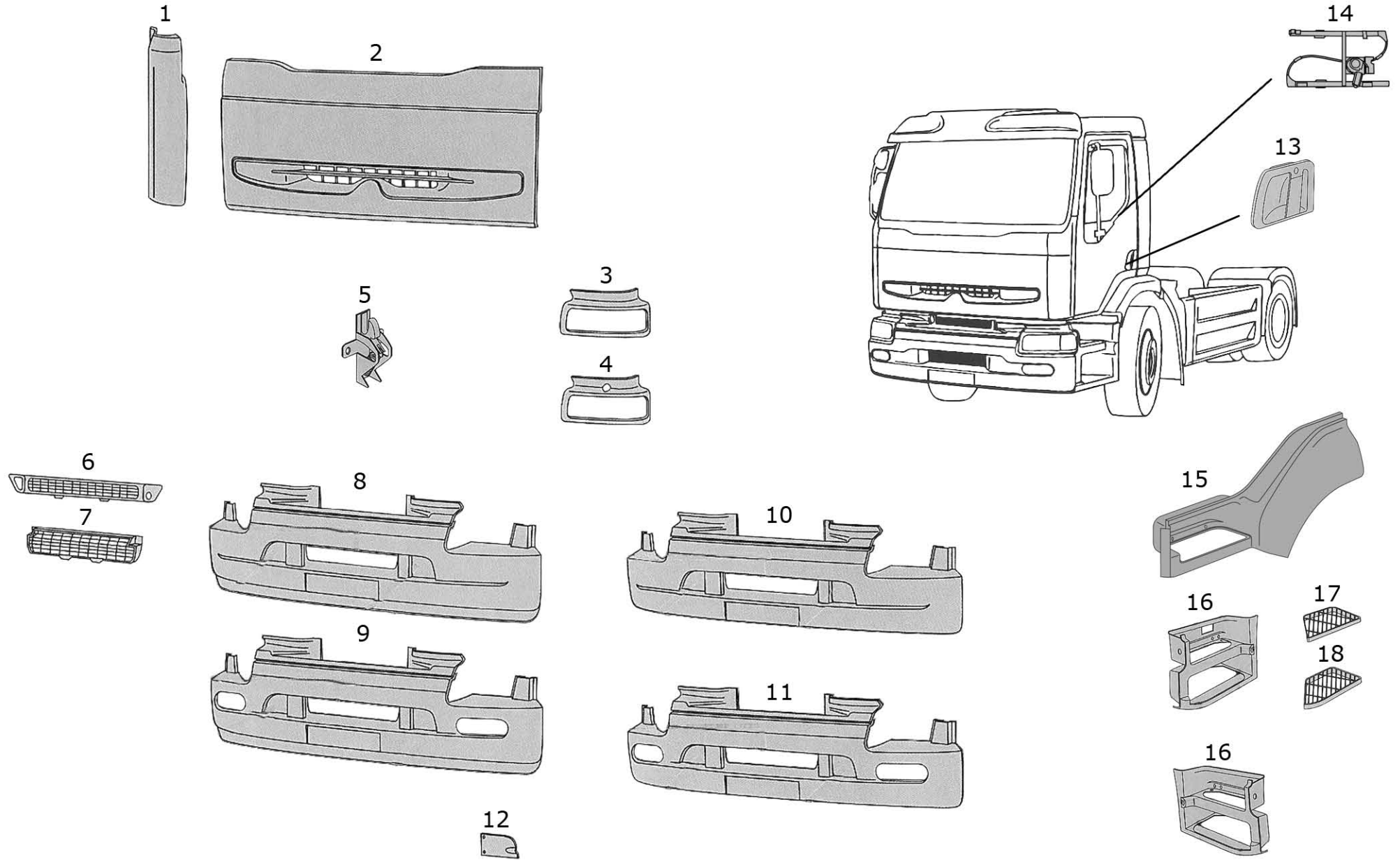



Section: 15, Pg: 4

1	609179	Cabin Corner L/H 5010445661
1	609180	Cabin Corner R/H 5010445662
2	609010	Front Grille Panel 5010301971 5010445793
3	609020	Headlamp Bezel Without Headlamp Wipers L/H 5001834444
3	609019	Headlamp Bezel Without Headlamp Wipers R/H 5001834442
4	609178	Headlamp Panel For Vehicles With Headlamp Wipers L/H 5001834446
4	609177	Headlamp Panel For Vehicles With Headlamp Wipers R/H 5001834445
5	690002	Front Grille Lock L/H & R/H 5010353170
6	609175	Upper Bumper Cover 5010301143
7	609176	Lower Bumper Cover 5010301144
8	609082	Front Bumper With Spoiler 5010225815
9	609084	Front Bumper With Spoiler & Lamp Holes 5010225819
10	609081	Front Bumper Without Spoiler 5010225813
11	609083	Front Bumper Without Spoiler & Lamp Holes 5010225817

12	609079	Bumper Blank L/H 5010225821
12	609080	Bumper Blank R/H 5010225822
13	609042	Door Handle L/H 5001858129
13	609041	Door Handle R/H 5001836268 5001858130
14	690010	Window Regulator L/H 5010301993
14	690009	Window Regulator R/H 5010301994 74824971947
15	690062	Wheel Arch L/H
15	690063	Wheel Arch R/H
16	609062	Footstep Well L/H 5010225068 7421304658
16	609063	Footstep Well R/H 5010225722
17	609181	Upper Footstep Grille (Plastic) L/H 5010544030
17	609182	Upper Footstep Grille (Plastic) R/H 5010544029
17	690037	Upper Footstep Grille (Aluminium) L/H & R/H
18	609009	Lower Footstep Grille (Plastic) L/H 5010544026
18	609008	Lower Footstep Grille (Plastic) R/H 5010544027
18	690004	Lower Footstep Grille (Aluminium) L/H & R/H 5010225398

Suffix Key; OE = Original Equipment, R = Reconditioned Equipment, OEM = Original Equipment Manufacturer, ALT = Alternative Supplier Part

OE Numbers used for Cross Referencing Purposes Only

sales@direct-sourcing-solutions.com www.direct-sourcing-solutions.com

Tel; +44 (0) 1653 668179 Fax; +44 (0) 1905 507755

Renault Premium II

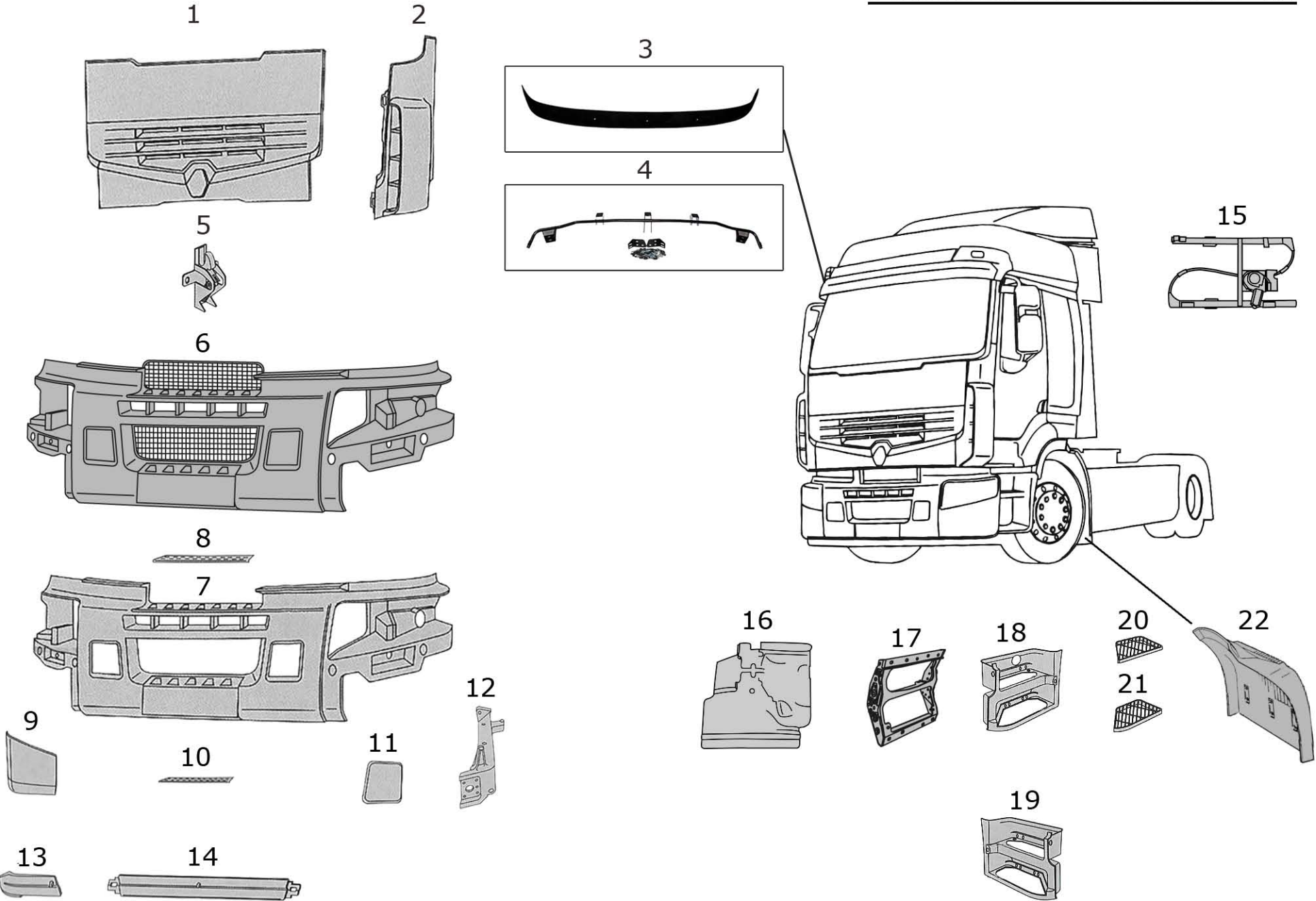



Section: 15, Pg: 6

1	609171	Front Grille Panel 5010578248	13	609090	Corner Spoiler L/H 5010578354
2	609174	Corner Panel L/H 5010578237	13	609091	Corner Spoiler R/H 5010578355
2	609173	Cabin Corner R/H 5010578238	14	609092	Centre Spoiler 5010578352
3	690011	Sunvisor (Low Cab) 7420937446	15	690010	Window Regulator L/H 5010301993
4	690012	Sunvisor Kit	15	690009	Window Regulator R/H 5010301994 74824971947
5	690002	Front Grille Lock L/H & R/H 5010353170	16	609066	Footstep Protection L/H 5010225404
6	690061	Front Bumper Complete (In Grey)	16	609067	Footstep Protection R/H 5010225405
7	609087	Front Bumper Incomplete 5010623600 7420928994	17	690028	Boarding Step Bracket L/H & R/H
8	609085	Upper Front Bumper Step 5010578346	18	609064	Footstep Well L/H (In Primer) 5010578378 5010578381
9	609088	Corner Bumper L/H (In Primer) 5010578335	18	690008	Footstep Well L/H With Hole (In Grey) 5010578376
9	609089	Corner Bumper R/H (In Primer) 5010578336	19	609065	Footstep Well R/H (In Primer) 5010578387 5010578878
9	690006	Corner Bumper L/H (In Grey) 5010578315	19	690007	Footstep Well R/H Without Hole (In Grey) 5010578876
9	690005	Corner Bumper R/H (In Grey) 5010578325	20	609181	Upper Footstep Grille (Plastic) L/H 5010544030
10	609086	Lower Front Bumper Step 5010578344	20	609182	Upper Footstep Grille (Plastic) R/H 5010544029
11	609183	Bumper Blank 5010578342	21	609009	Lower Footstep Grille (Plastic) L/H 5010544026
12	609185	Bumper Bracket L/H 7420819616	21	609008	Lower Footstep Grille (Plastic) R/H 5010544027
12	609184	Bumper Bracket R/H 7420819613	21	690004	Lower Footstep Grille (Aluminium) L/H & R/H 5010225398
			22	609061	Mudguard L/H & /H 5010578754

Suffix Key; OE = Original Equipment, R = Reconditioned Equipment OEM = Original Equipment Manufacturer, ALT = Alternative Supplier Part

OE Numbers used for Cross Referencing Purposes Only

sales@direct-sourcing-solutions.com www.direct-sourcing-solutions.com

Tel; +44 (0) 1653 668179 Fax; +44 (0) 1905 507755

Renault Kerax

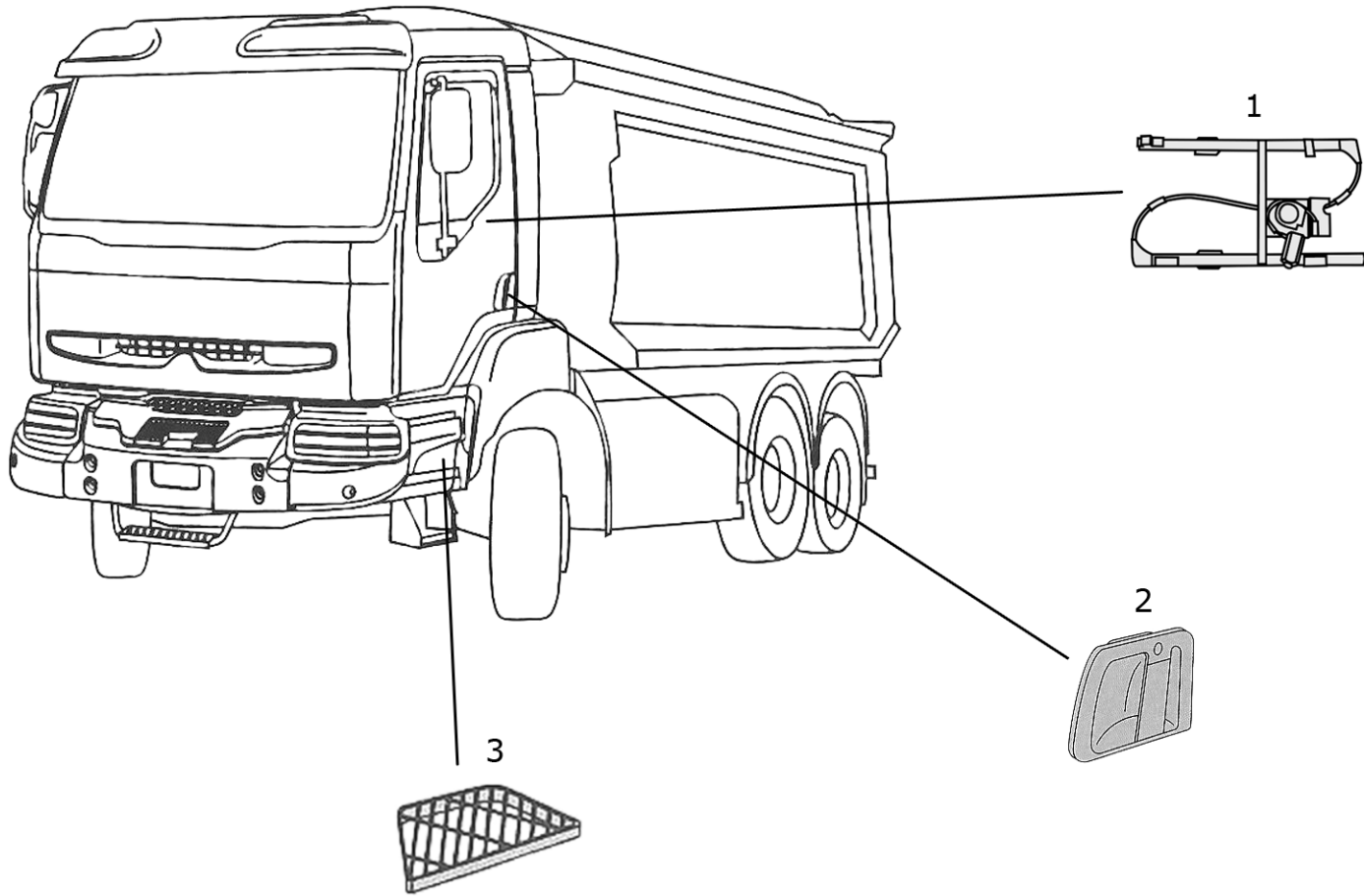



Section: 15, Pg: 8

1	690010	Window Regulator L/H 5010301993
1	690009	Window Regulator R/H 5010301994 74824971947
2	609042	Door Handle L/H 5001858129
2	609041	Door Handle R/H 5001836268 5001858130
3	609181	Upper Footstep Grille (Plastic) L/H 5010544030
3	609182	Upper Footstep Grille (Plastic) R/H 5010544029

Suffix Key; OE = Original Equipment, R = Reconditioned Equipment OEM = Original Equipment Manufacturer, ALT = Alternative Supplier Part

OE Numbers used for Cross Referencing Purposes Only

sales@direct-sourcing-solutions.com www.direct-sourcing-solutions.com

Tel; +44 (0) 1653 668179 Fax; +44 (0) 1905 507755

Renault AE Magnum

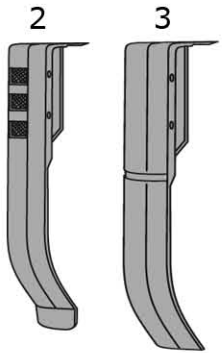
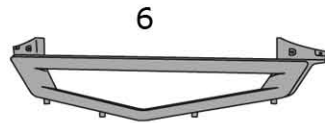
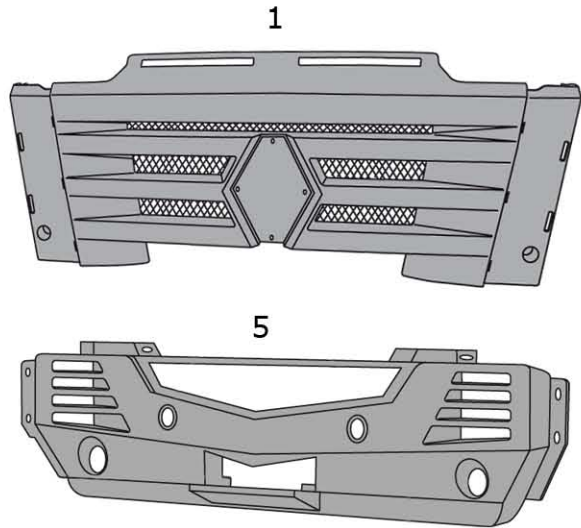
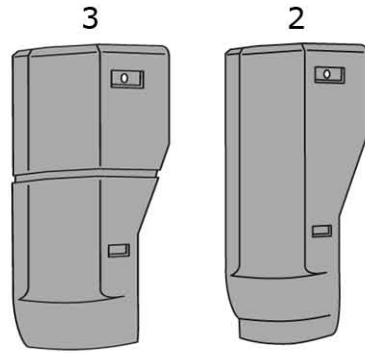
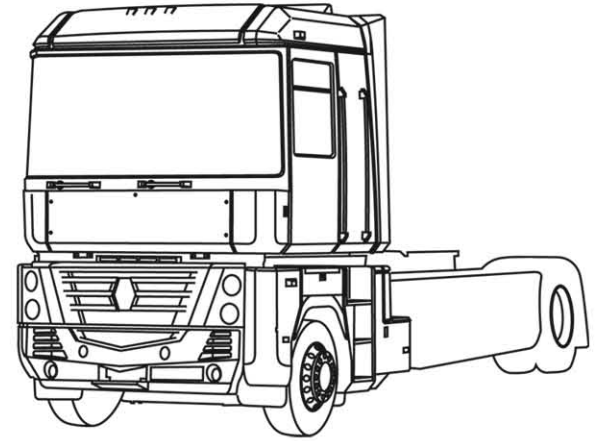



Section: 15, Pg: 10

1	690072	Front Grille Panel
2	609077	Corner Bumper With Air Slit L/H (Second Series) 5010574311
2	609076	Corner Bumper With Air Slit R/H (Second Series) 5010574309
3	609075	Corner Bumper Without Air Slit L/H (First Series) 5010219006
3	609073	Corner Bumper Without Air Slit R/H (First Series) 5010219008
3	609074	Corner Bumper With Air Slit R/H (First Series)
4	609044	External Door Handle L/H 5010353608
4	609043	External Door Handle R/H 5010441111
5	609078	Front Bumper (Second Series) 5010544561
6	609013	Bumper Grille (Second Series) 5010468582

Suffix Key; OE = Original Equipment, R = Reconditioned Equipment OEM = Original Equipment Manufacturer, ALT = Alternative Supplier Part

OE Numbers used for Cross Referencing Purposes Only

sales@direct-sourcing-solutions.com www.direct-sourcing-solutions.com

Tel; +44 (0) 1653 668179 Fax; +44 (0) 1905 507755

Wing Section - Renault Premium

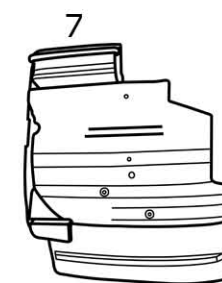
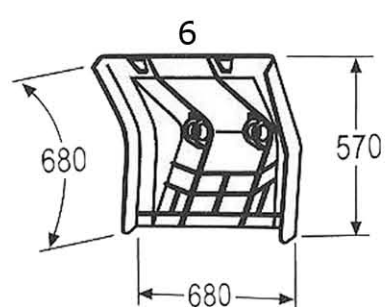
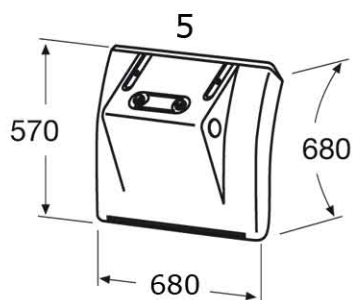
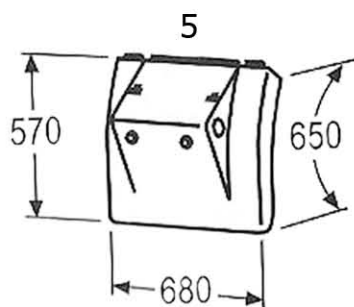
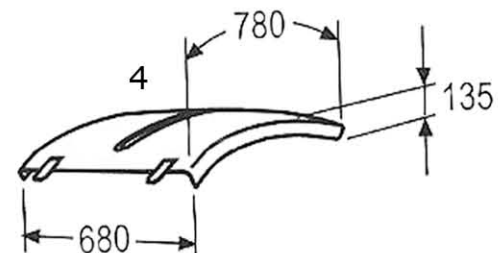
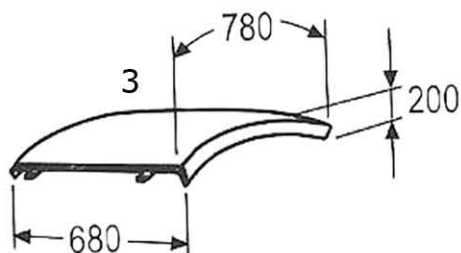
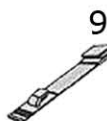
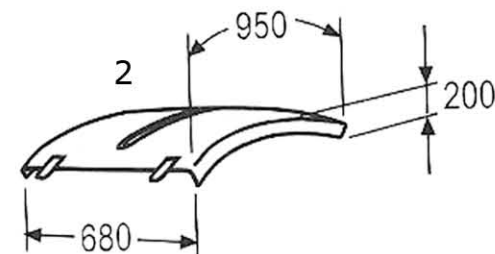
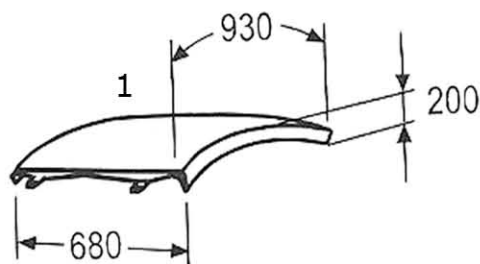
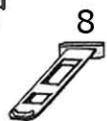
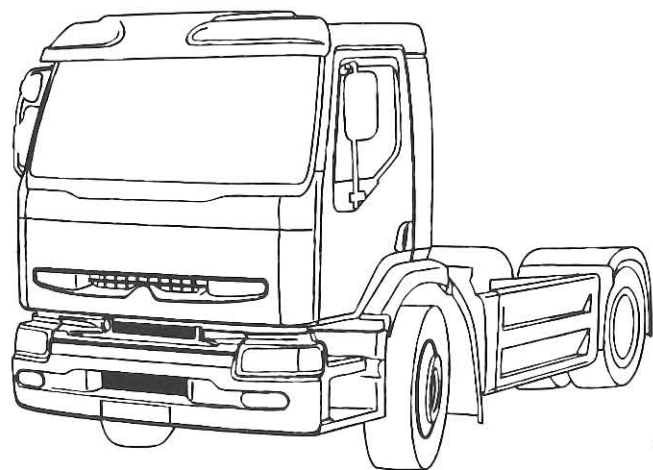



Section: 15, Pg: 12

1	609058	Rear Mudguard L/H & R/H 5010132441
2	609054	Rear Mudguard L/H & R/H 5010314951
3	609057	Rear Mudguard L/H & R/H 5010228253
4	609055	Rear Mudguard L/H & R/H 5010314952
5	609056	Rear Mudguard (Black) L/H & R/H 5010228158
5	690035	Rear Mudguard L/H & R/H
6	609170	Rear Half Mudguard L/H & R/H 5001856195
7	690036	Mudflap
8	690054	Rear Wing Strap 7420498623
9	609002	Mudguard Tensioner Strap 5001842757
10	609005	Mudguard Tensioner 5001856184

Suffix Key; OE = Original Equipment, R = Reconditioned Equipment OEM = Original Equipment Manufacturer, ALT = Alternative Supplier Part

OE Numbers used for Cross Referencing Purposes Only

sales@direct-sourcing-solutions.com www.direct-sourcing-solutions.com

Tel; +44 (0) 1653 668179 Fax; +44 (0) 1905 507755

Wing Section - Renault Premium II

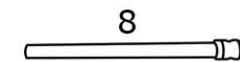
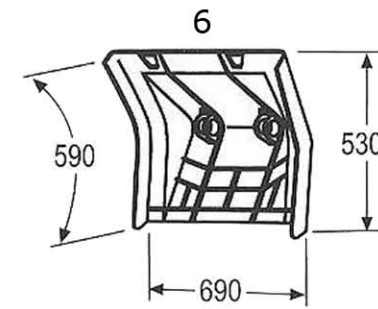
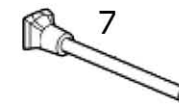
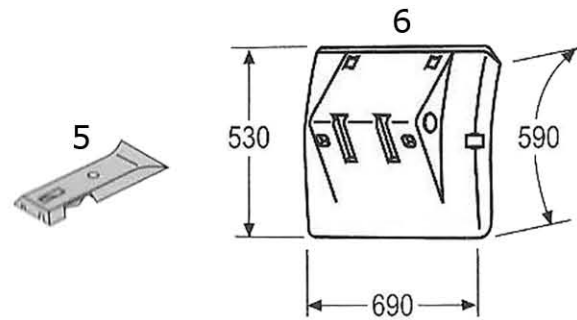
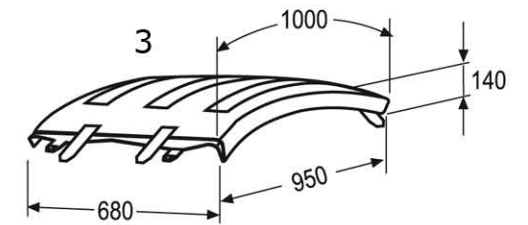
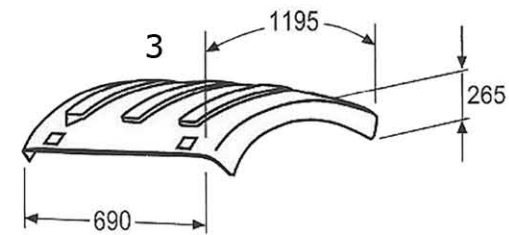
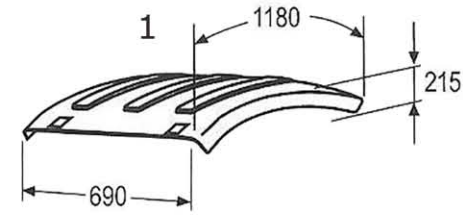
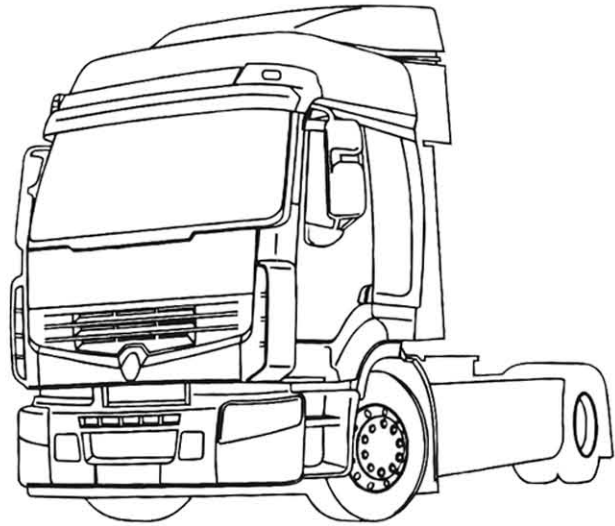



Section: 15, Pg: 14

1	690055	Rear Wing Top 7420936768
2	690054	Rear Wing Strap 7420498623
3	690057	Rear Wing Top (High Height) 7420936772
3	690013	Rear Wing Top (Low Height) 7421094389
4	690058	Rear Wing Support Bracket
5	609172	Rear Wing Bracket 7420721840
6	609059	Rear Mudguard L/H Front Part 7420583442
6	609060	Rear Mudguard R/H Front Part 7420583447
7	690025	Rear Wing Stay 7401079959
8	690014	Rear Wing Stay Support Bracket 7421094415

Suffix Key; OE = Original Equipment, R = Reconditioned Equipment OEM = Original Equipment Manufacturer, ALT = Alternative Supplier Part

OE Numbers used for Cross Referencing Purposes Only

sales@direct-sourcing-solutions.com www.direct-sourcing-solutions.com

Tel; +44 (0) 1653 668179 Fax; +44 (0) 1905 507755

Wing Section - Renault AE Magnum

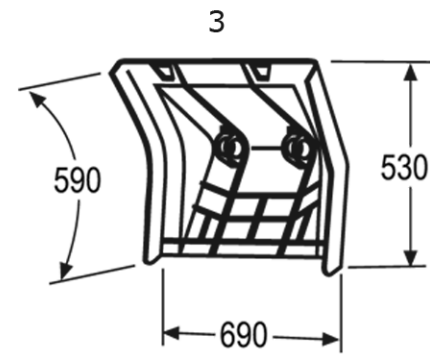
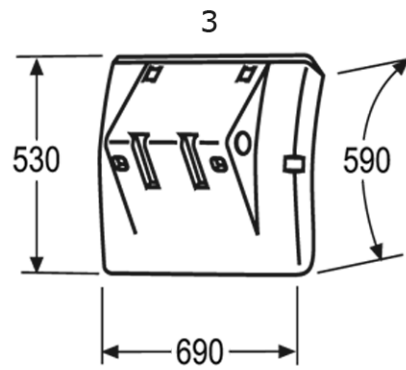
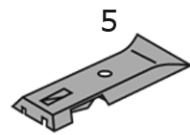
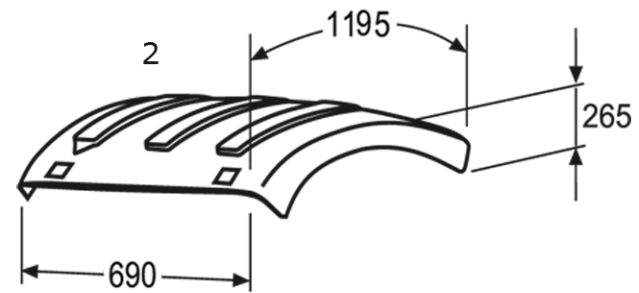
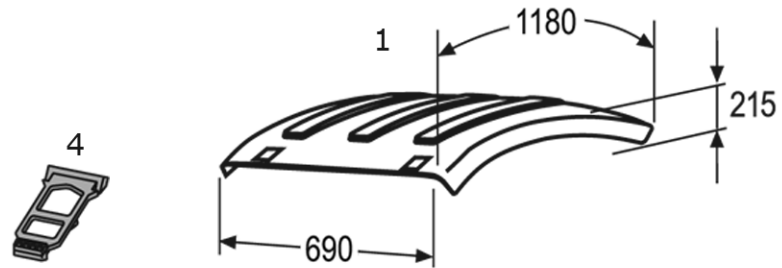
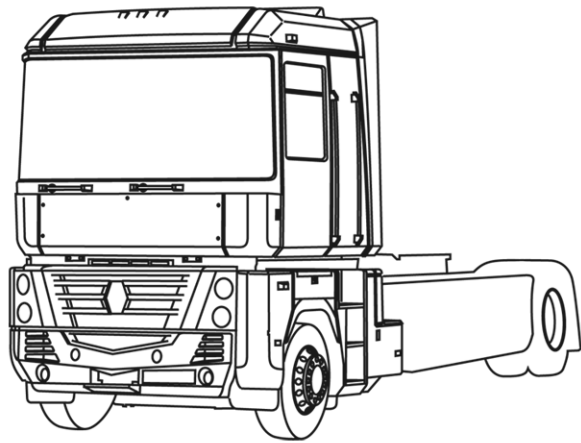



1	690055	Rear Wing Top 7420936768
2	690057	Rear Wing Top 7420936772
3	690059	Rear Wing Section 7420583488 7420771757
4	690054	Rear Wing Strap 7420498623
5	609172	Rear Mudguard Cover 7420721840
6	690060	Rear Mudguard 1/2 Clamp Bracket

Section: 15, Pg: 16

Suffix Key; OE = Original Equipment, R = Reconditioned Equipment OEM = Original Equipment Manufacturer, ALT = Alternative Supplier Part

OE Numbers used for Cross Referencing Purposes Only

sales@direct-sourcing-solutions.com www.direct-sourcing-solutions.com

Tel; +44 (0) 1653 668179 Fax; +44 (0) 1905 507755

MIRRORS - MIDLUM 1818, PREMIUM (DISTRIBUTION), KERAX 05>2006

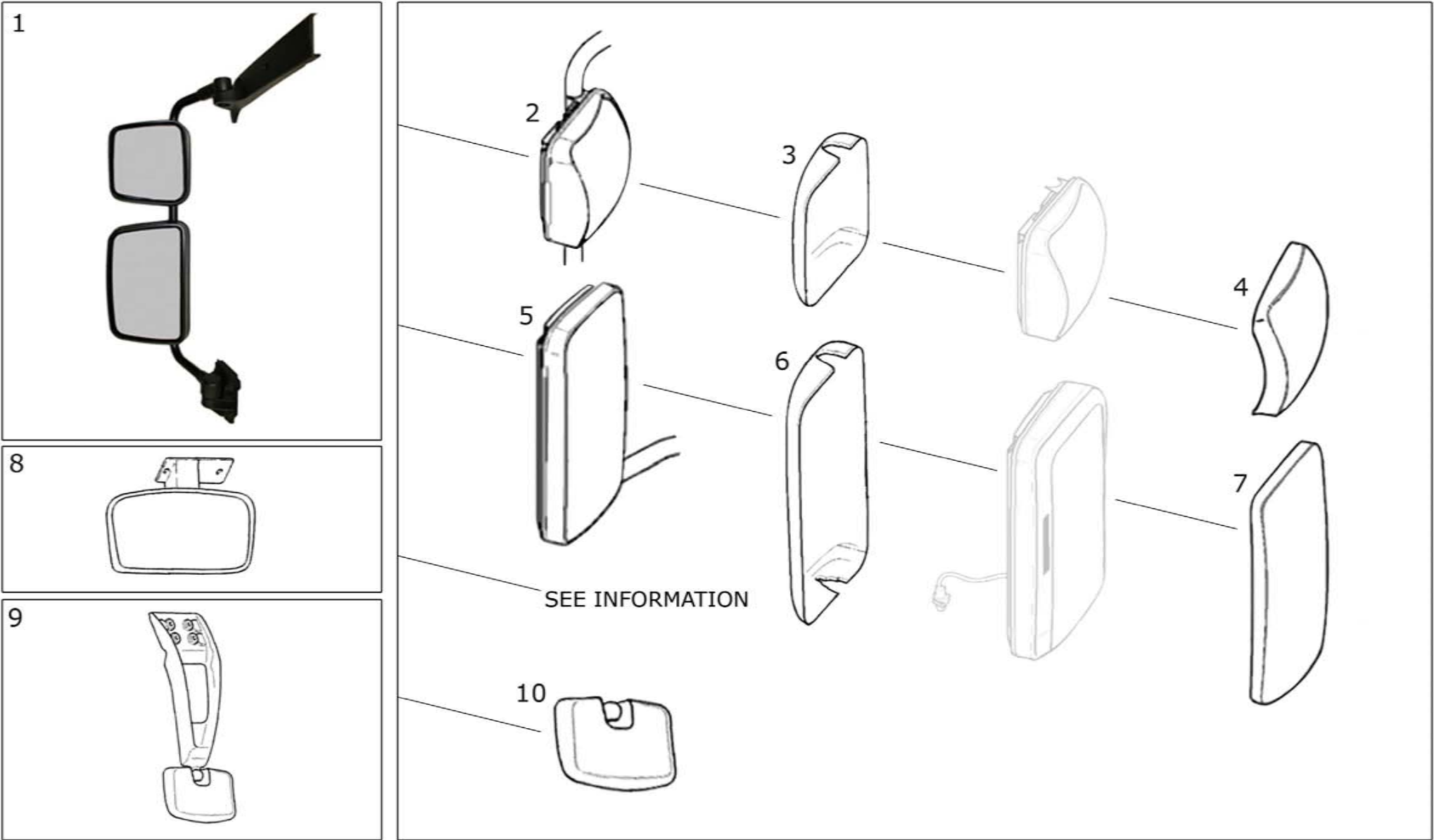



Section: 15, Pg: 18

1	690064	Complete Mirror Assembly L/H Heated 24V Manual Adjustment, Short Arm (100mm) 880 x 340mm
1	690065	Complete Mirror Assembly L/H Heated 24V Electrical Adjustment, Short Arm (100mm) 880 x 340mm
1	690066	Complete Mirror Assembly L/H Heated 24V Manual Adjustment, Long Arm (200mm) 880 x 440mm
1	690067	Complete Mirror Assembly L/H Heated 24V Electrical Adjustment, Long Arm (200mm) 880 x 440mm
2	690042	Complete Wide Angle Mirror Assembly L/H Heated 24V 245 x 230mm 7420862809
2	690043	Complete Wide Angle Mirror Assembly R/H Heated 24V 245 x 230mm 7420862813
3	690044	Wide Angle Mirror Cowl L/H & R/H 7420862800
4	690045	Wide Angle Mirror Glass L/H Heated 24V 200 x 197mm 7420862810
4	690046	Wide Angle Mirror Glass R/H Heated 24V 200 x 197mm 7420862815
5	690047	Main Mirror Assembly L/H & R/H Heated 24V Manual Adjustment 370 x 245mm 7420862782
5	690048	Main Mirror Assembly L/H & R/H Heated 24V Electrical Adjustment 370 x 245mm 7420866665 7420913815
6	690049	Main Mirror Cowl L/H & R/H 7420862779

7	690050	Main Mirror Glass Heated 24V 337 x 202mm 7420862795
8	690051	Kerb Mirror 260 x 229mm 5010578512
9	690052	Complete Front View Mirror Assembly 725 x 319 x 126mm 7420849837
10	690053	Front View Mirror 319 x 187mm 7421020285

Suffix Key; OE = Original Equipment, R = Reconditioned Equipment OEM = Original Equipment Manufacturer, ALT = Alternative Supplier Part

OE Numbers used for Cross Referencing Purposes Only

sales@direct-sourcing-solutions.com www.direct-sourcing-solutions.com

Tel; +44 (0) 1653 668179 Fax; +44 (0) 1905 507755

MIRRORS - MIDLINER, MIDLUM, PREMIUM NEW GENERATION >09/2005

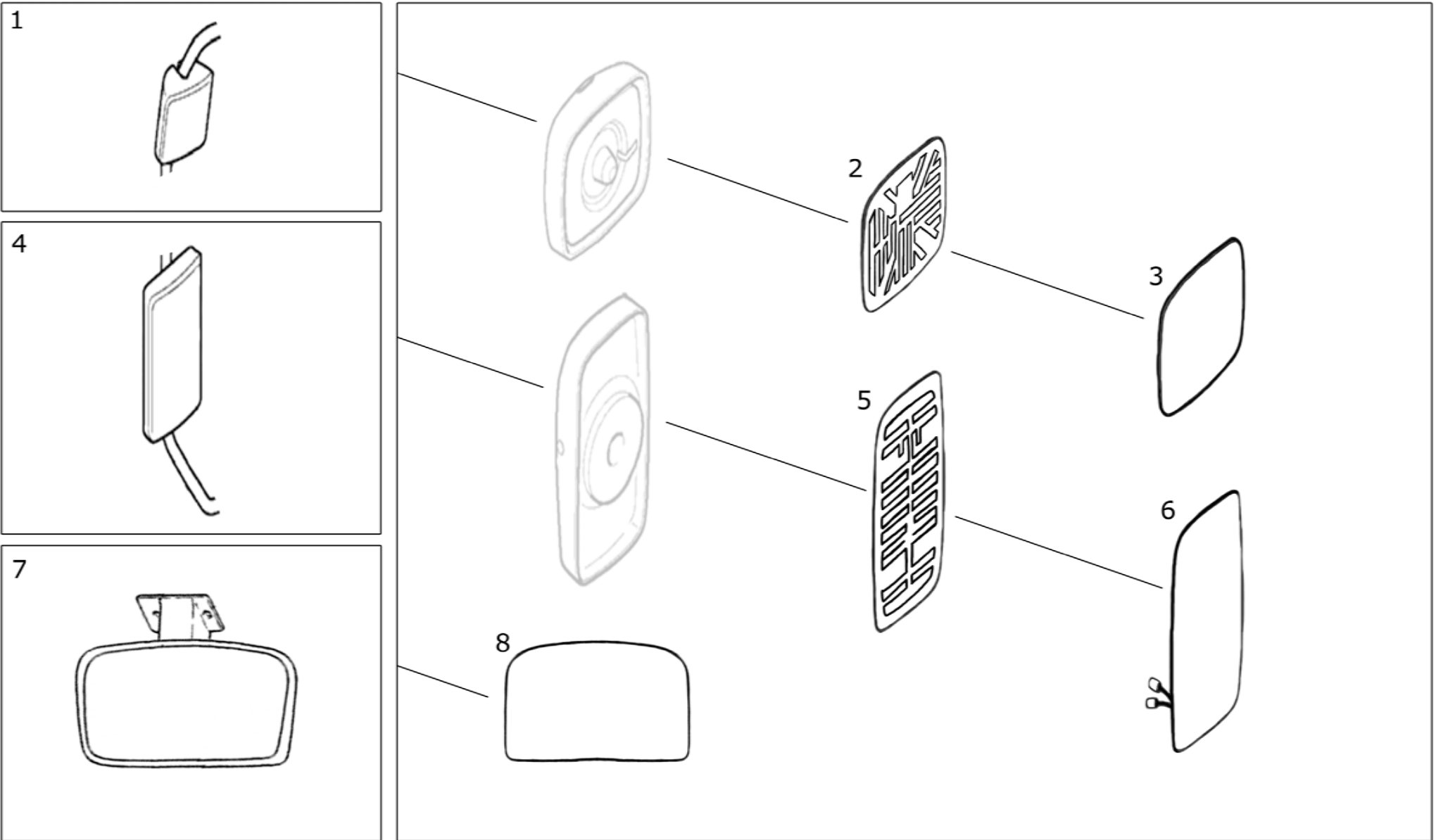



Section: 15, Pg: 20

1	690032	Complete Wide Angle Mirror Assembly L/H & R/H Heated 24V - New Radius 199 x 199mm 7421276373
2	690033	Wide Angle Mirror Heating Element 24V 173 x 138mm
3	690034	Wide Angle Mirror Glass L/H & R/H Heated 24V 189 x 189mm
4	609188	Complete Main Mirror Assembly L/H & R/H Heated 24V Manual Adjustment 380 x 185mm 5001833026 5001856292
4	609186	Complete Main Mirror Assembly L/H & R/H Heated 24V Manual Adjustment 400 x 210mm 5001824148
4	609137	Complete Main Mirror Assembly L/H & R/H Heated 24V & Electrical Adjustment 400 x 210mm 5001856290
5	690039	Main Mirror Heating Element 24V 300 x 150mm
6	609134	Main Mirror Glass L/H & R/H Heated 24V 370 x 176mm 5001832947
6	609187	Main Mirror Glass L/H & R/H Heated 24V 369 x 180mm 5001856614 5010093515
7	690040	Complete Kerb Mirror Assembly (New Regulation Glass) 290 x 170mm 7485115895
8	690041	Kerb Mirror Glass 290 x 170mm

Suffix Key; OE = Original Equipment, R = Reconditioned Equipment OEM = Original Equipment Manufacturer, ALT = Alternative Supplier Part

OE Numbers used for Cross Referencing Purposes Only

sales@direct-sourcing-solutions.com www.direct-sourcing-solutions.com

Tel; +44 (0) 1653 668179 Fax; +44 (0) 1905 507755

MIRRORS - PREMIUM (ROUTO 2711) 10/2005>

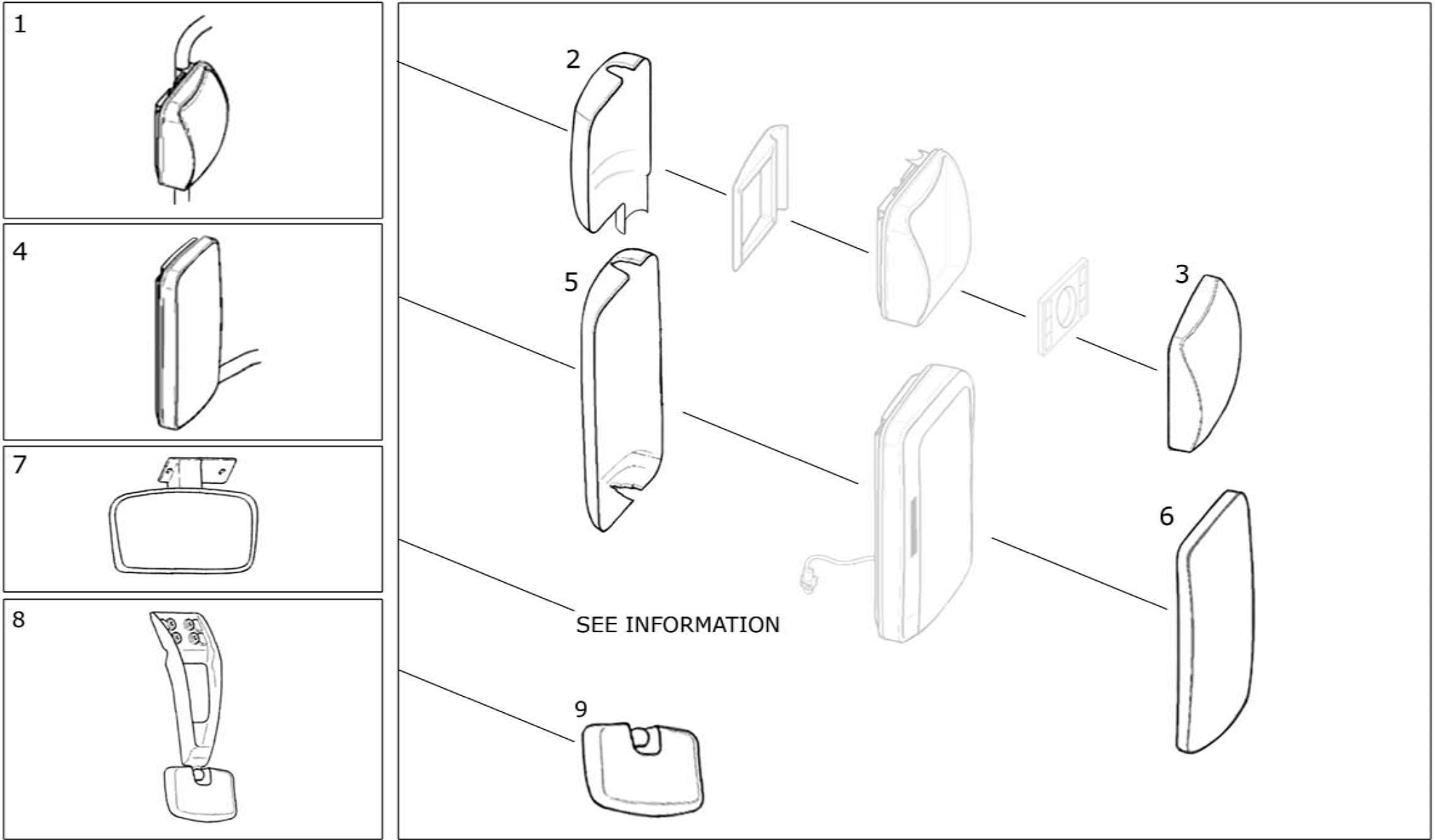



Section: 15, Pg: 22

1	609120	Complete Wide Angle Mirror Assembly L/H Heated 24V Electrical Adjustment 245 x 230mm 7420904268
1	609121	Complete Wide Angle Mirror Assembly R/H Heated 24V Electrical Adjustment 245 x 230mm 7420904269
2	609191	Wide Angle Mirror Cowl L/H 7420903882
2	609192	Wide Angle Mirror Cowl R/H 7420903883
3	609189	Wide Angle Mirror Glass L/H Heated 24V 200 x 197mm 7420903745
3	609190	Wide Angle Mirror Glass R/H Heated 24V 200 x 197mm 7420903883
4	690048	Main Mirror Assembly L/H & R/H Heated 24V Electrical Adjustment 370 x 245mm 7420866665 7420913815
5	690049	Main Mirror Cowl L/H & R/H 7420862779
6	690050	Main Mirror Glass Heated 24V 337 x 202mm 7420862795
7	690051	Kerb Mirror 260 x 229mm 510578512
8	690052	Complete Front View Mirror Assembly 725 x 319 x 126mm 7420849837
9	690053	Front View Mirror 319 x 187mm 7421020285

Suffix Key; OE = Original Equipment, R = Reconditioned Equipment OEM = Original Equipment Manufacturer, ALT = Alternative Supplier Part

OE Numbers used for Cross Referencing Purposes Only

sales@direct-sourcing-solutions.com www.direct-sourcing-solutions.com

Tel; +44 (0) 1653 668179 Fax; +44 (0) 1905 507755

MIRRORS - AE MAGNUM 02/1992>

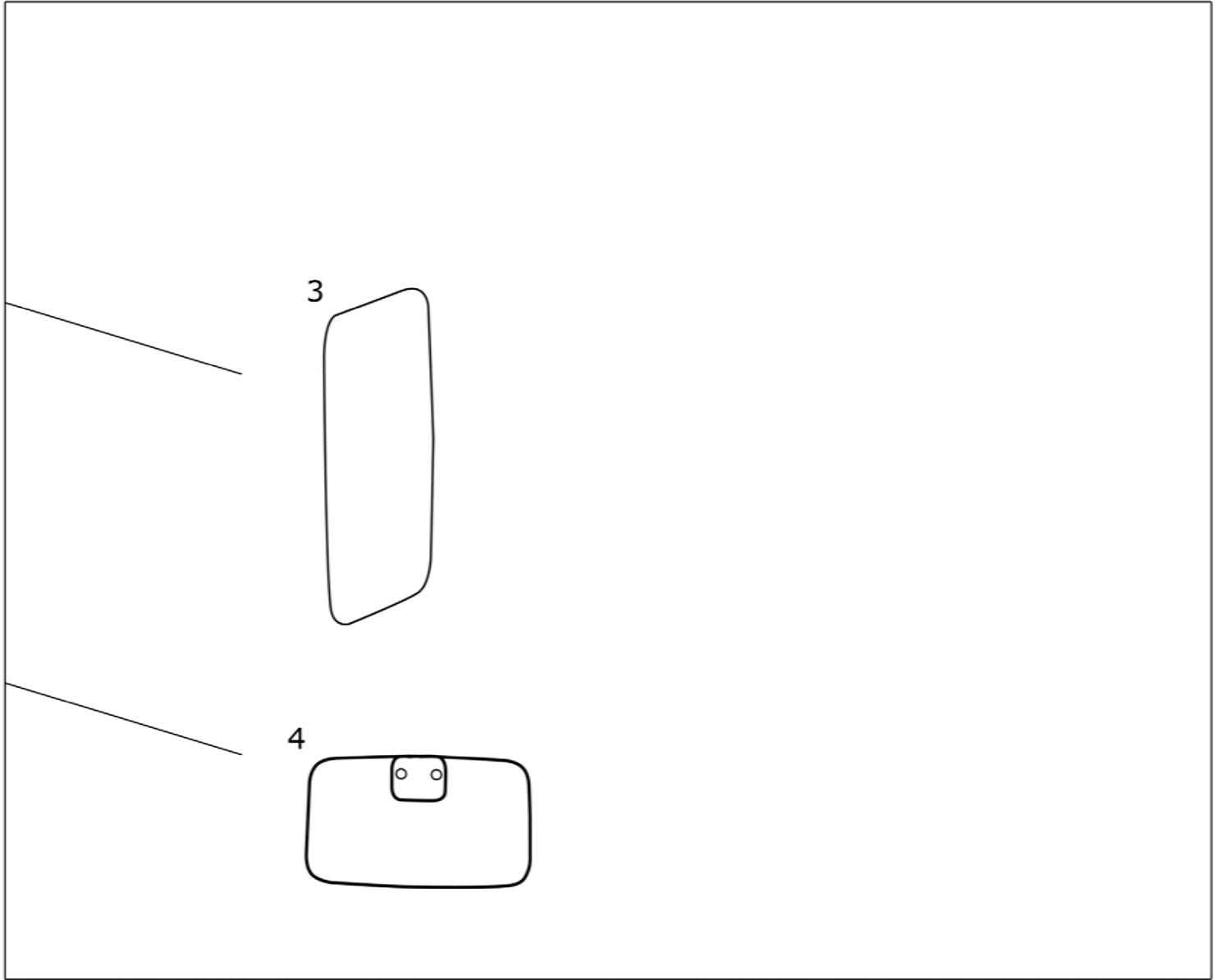
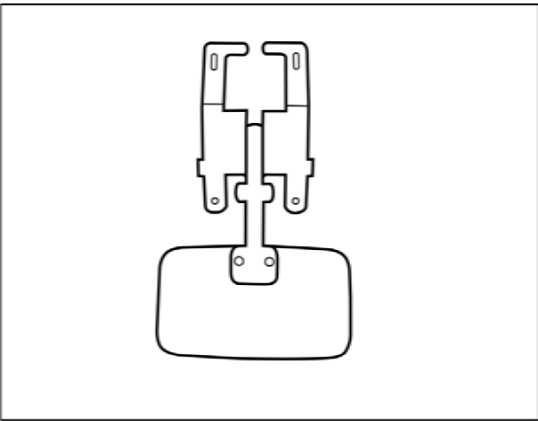
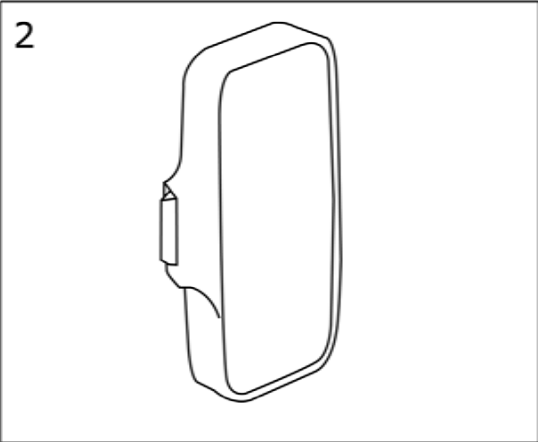
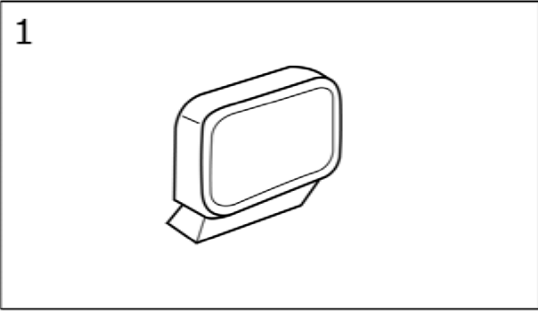



Section: 15, Pg: 24

1	690027	Complete Wide Angle Mirror Assembly Heated 24V 225 x 220mm 5001873672
2	609109	Complete Main Mirror Assembly Heated 24V L/H 480 x 200mm 5001838475
2	609108	Complete Main Mirror Assembly Heated 24V R/H 480 x 200mm 5001842202
3	609139	Main Mirror Glass Heated 24V L/H & R/H 465 x 190mm 5000289377
4	690053	Front View Mirror 319 x 187mm 7421020285

Suffix Key; OE = Original Equipment, R = Reconditioned Equipment OEM = Original Equipment Manufacturer, ALT = Alternative Supplier Part

OE Numbers used for Cross Referencing Purposes Only

sales@direct-sourcing-solutions.com www.direct-sourcing-solutions.com

Tel; +44 (0) 1653 668179 Fax; +44 (0) 1905 507755



Cab Mountings

<p>690018 5010552266 Cab Mounting PREMIUM /TR/PR, PREMIUM II TR/PR/ DXi 7, KERAX /DXi 11/13</p>	
<p>690031 5010269380 7420850895 Cab Mounting Bush, Rear PREMIUM /TR/PR, PREMIUM II TR/PR/ DXi 7, KERAX /DXi 11/13</p>	
<p>690073 7421271207 Cab Mounting Bush, Rear PREMIUM /TR/PR, PREMIUM II TR/PR/ DXi 7, KERAX /DXi 11/13</p>	
<p>690068 5010239248 Cab Suspension Rubber Bump Stop PREMIUM /TR/PR, KERAX, MAGNUM DXi 12/13</p>	

Suffix Key; OE = Original Equipment, R = Reconditioned Part

OEM = Original Equipment Manufacturer, ALT = Alternative Supplier Part

OE Numbers used for Cross Reference Purposes Only

sales@direct-sourcing-solutions.com www.direct-sourcing-solutions.com

Tel; +44 (0) 1653 668179 Fax; +44 (0) 1905 507755

Section: 15, Pg: 25



Cab Air Bags

<p>609000 5010130797 5010629414 Cab Air Bag, Front MIDLUM DXi 5/7, PREMIUM /TR/PR, PREMIUM II TR/PR/ DXi 7, KERAX /DXi 11/13</p>	
--	---

<p>690017 5010320096 Cab Air Bag, Front & Rear AE MAGNUM, MAGNUM E-TECH</p>	
---	---



<p>690071 5010491301 Cab Air Bag, Front MAGNUM DXi 12/13</p>	
--	---

--	--

--	--



Cab Shock Absorbers

<p>690030 7420840318 5010269605 5010460113 5010615880 Cab Shock Absorber, Front PREMIUM /TR/PR, PREMIUM II TR/PR/ DXi 7, KERAX</p>	
<p>609001 5010228908 5010269674 5010316783 Cab Air Shock Absorber Assembly, Rear PREMIUM /TR/PR, KERAX</p>	

Direct Sourcing Solutions

Renault Catalogue 6.14.1

Section 15: Cab & Body



Cab Tilt Pumps

<p>690020 5010316438 Cab Tilt Pump RHD M/S, PREMIUM TR, KERAX</p>	<p>Alternatives; 690020OEM</p> 
<p>690003OEM 5010316404 7482053294 Cab Tilt Pump RHD PREMIUM /TR/PR</p>	<p>Alternatives; 690003</p> 
<p>690026OEM 5010629361 Cab Tilt Pump RHD PREMIUM II TR/PR DXi 7, KERAX DXi 11/13</p>	

Suffix Key; OE = Original Equipment, R = Reconditioned Part
OEM = Original Equipment Manufacturer, ALT = Alternative Supplier Part

OE Numbers used for Cross Reference Purposes Only

sales@direct-sourcing-solutions.com www.direct-sourcing-solutions.com

Tel; +44 (0) 1653 668179 Fax; +44 (0) 1905 507755

Section: 15, Pg: 28



Direct Sourcing Solutions

Renault Catalogue 6.14.1

Section 15: Cab & Body



Cab Jack Rams

<p>690016 5010316793 Cab Ram PREMIUM /TR/PR, KERAX</p>	
<p>690070 5010629350 Cab Ram PREMIUM II TR/PR</p>	

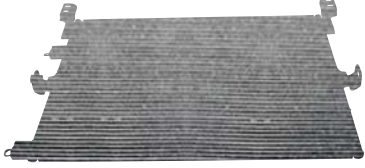

Air Conditioning Radiators

<p>690069 5001875436 Air Conditioning Condenser Radiator PREMIUM II TR/PR/ DXi 7, KERAX DXi 11/13, MAGNUM DXi 12/13</p>	
---	---

--	--

--	--

--	--

--	--



Air Conditioning Compressors

690021

5001867206 5010605053 7482492298

Air Conditioning Compressor

PREMIUM II TR/PR, KERAX /DXi 11/13, MAGNUM DXi 13



--	--

--	--

--	--

--	--

Suffix Key; OE = Original Equipment, R = Reconditioned Part

OEM = Original Equipment Manufacturer, ALT = Alternative Supplier Part

OE Numbers used for Cross Reference Purposes Only

sales@direct-sourcing-solutions.com www.direct-sourcing-solutions.com

Tel; +44 (0) 1653 668179 Fax; +44 (0) 1905 507755

Section: 15, Pg: 31



Wipers & Associated Parts

<p>690001</p> <p>Wiper Blade 650mm PREMIUM, KERAX Pack Of 2</p>	



As A UK Distributor Of KAB Seating
We Stock A Range Of Universal Seats
And Adaptor Brackets To Suit Most
Makes Of Commercial Vehicle; Please
Contact Us For Details.

Suffix Key; OE = Original Equipment, R = Reconditioned Part

OEM = Original Equipment Manufacturer, ALT = Alternative Supplier Part

OE Numbers used for Cross Reference Purposes Only

sales@direct-sourcing-solutions.com www.direct-sourcing-solutions.com

Tel; +44 (0) 1653 668179 Fax; +44 (0) 1905 507755

Section: 15, Pg: 33



Seats, Fittings & Associated Parts

<p>209742</p> <p>Drivers Air Seat Complete With Runners, No Seat Belt - KAB 712</p>	
<p>209744</p> <p>Drivers Air Seat, No Seat Belt - KAB 714</p>	
<p>209704</p> <p>Drivers Air Seat Complete With Seat Belt & Headrest - KAB 714B</p>	
<p>290020</p> <p>Drivers Air Seat Complete With Seat Belt & Headrest LHD L/H</p>	
<p>290040</p> <p>Drivers Air Seat Complete With Seat Belt & Headrest (Luxury) - KAB GSX300</p>	

Suffix Key; OE = Original Equipment, R = Reconditioned Part
OEM = Original Equipment Manufacturer, ALT = Alternative Supplier Part

OE Numbers used for Cross Reference Purposes Only



sales@direct-sourcing-solutions.com www.direct-sourcing-solutions.com

Tel; +44 (0) 1653 668179 Fax; +44 (0) 1905 507755

Section: 15, Pg: 34



Seats, Fittings & Associated Parts

<p>209737</p> <p>Headrest</p>	
<p>209752</p> <p>Seat Z Bracket Adaptor - KAB 150380</p>	

Direct Sourcing Solutions

Renault Catalogue 6.14.1



This Page Is Intentionally Left Blank

Suffix Key; OE = Original Equipment, R = Reconditioned Part
OEM = Original Equipment Manufacturer, ALT = Alternative Supplier Part

OE Numbers used for Cross Reference Purposes Only

sales@direct-sourcing-solutions.com www.direct-sourcing-solutions.com

Tel; +44 (0) 1653 668179 Fax; +44 (0) 1905 507755

Direct Sourcing Solutions

Renault Catalogue 6.14.1

16: Electrical Index



Alternators	Pg: 2
Battery Covers	Pg: 1
Lighting: Fog Lamps	Pg: 10
Lighting: Front Indicator Lamps	Pg: 8-9
Lighting: Headlamps & Associated Parts	Pg: 4-7
Lighting: Rear Lamps & Associated Parts	Pg: 11-12
Lighting: Side Marker Lamps	Pg: 13
Starter Motors	Pg: 3
Washer & Wiper Equipment: Washer Pumps	Pg: 14

Suffix Key; OE = Original Equipment, R = Reconditioned Part
OEM = Original Equipment Manufacturer, ALT = Alternative Supplier Part

OE Numbers used for Cross Reference Purposes Only

sales@direct-sourcing-solutions.com www.direct-sourcing-solutions.com

Tel; +44 (0) 1653 668179 Fax; +44 (0) 1905 507755



Battery Covers

<p>690038 5010314883 7420947987 Battery Cover MIDLUM</p>	
<p>680015 7420842821 Battery Box Cover PREMIUM /TR, MAGNUM DXi 13 Two Piece Cover - See 680016 For Other Half</p>	
<p>680016 7420842848 Battery Box Cover PREMIUM /TR, MAGNUM DXi 13 Two Piece Cover - See 680015 For Other Half</p>	
<p>609004 5010505041 5010269882 Battery Cover PREMIUM /TR/PR</p>	

Suffix Key; OE = Original Equipment, R = Reconditioned Part
OEM = Original Equipment Manufacturer, ALT = Alternative Supplier Part

OE Numbers used for Cross Reference Purposes Only

sales@direct-sourcing-solutions.com www.direct-sourcing-solutions.com

Tel; +44 (0) 1653 668179 Fax; +44 (0) 1905 507755

Section: 16, Pg: 1



Alternators

680008

7485003228 7421324077 5010306801 5010306710 5010306007 5001859216

Alternator 80A

MIDLUM /TR/PR, PREMIUM, KERAX



680024

7420842445

Alternator 110A

PREMIUM II TR/PR, KERAX /DXi 11

Use Regulator 208569



680021

5010589551 7421429789

Alternator 110A (Bosch Type)

KERAX DXi 13, MAGNUM DXi 13

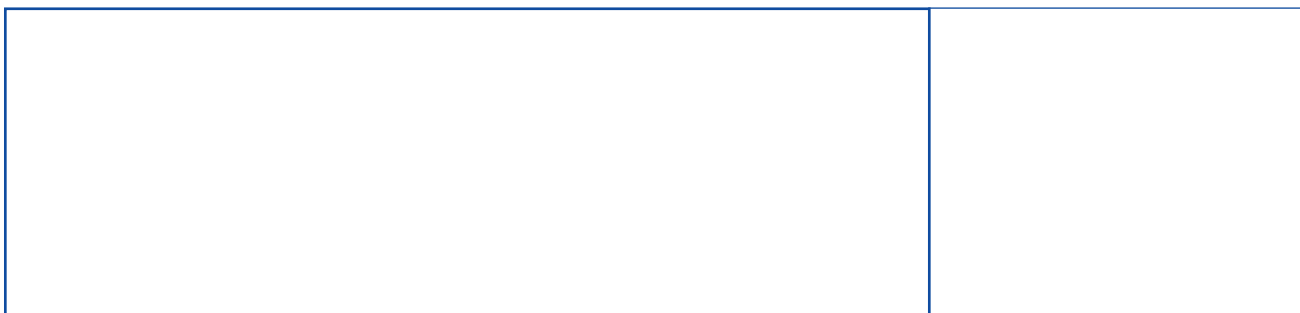
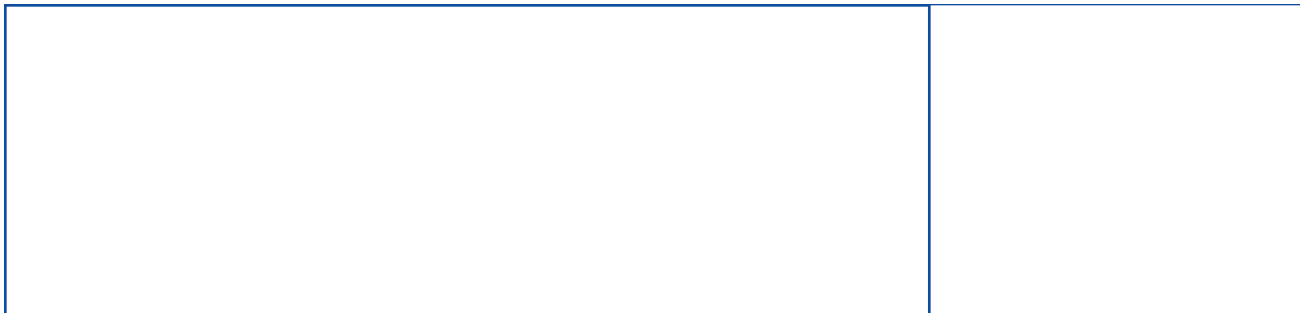

Suffix Key; OE = Original Equipment, R = Reconditioned Part

OEM = Original Equipment Manufacturer, ALT = Alternative Supplier Part

OE Numbers used for Cross Reference Purposes Only

sales@direct-sourcing-solutions.com www.direct-sourcing-solutions.com

Tel; +44 (0) 1653 668179 Fax; +44 (0) 1905 507755

Section: 16, Pg: 2

Direct Sourcing Solutions

Renault Catalogue 6.14.1

Section 16: Electrical



Starter Motors

680027

7420732977 7421036377 5001866702

Starter Motor

PREMIUM



680003

5001853713 5010306592 5010480196 5010508380

Starter Motor

PREMIUM /TR/PR, KERAX

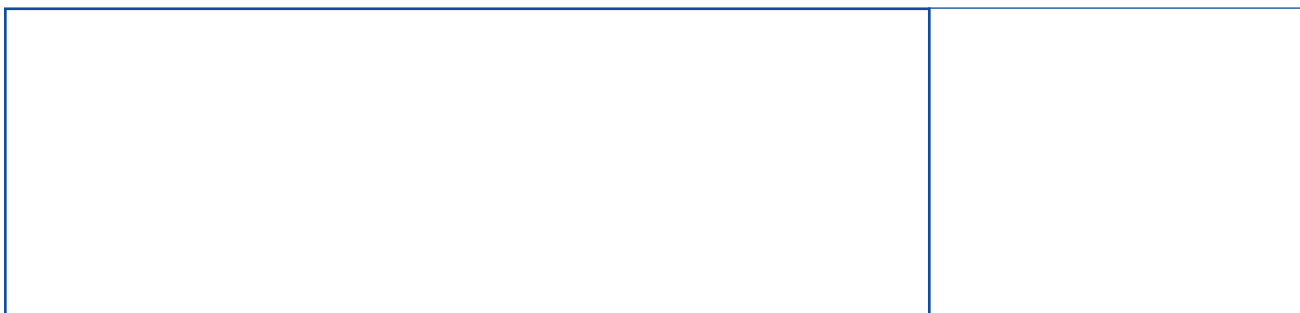
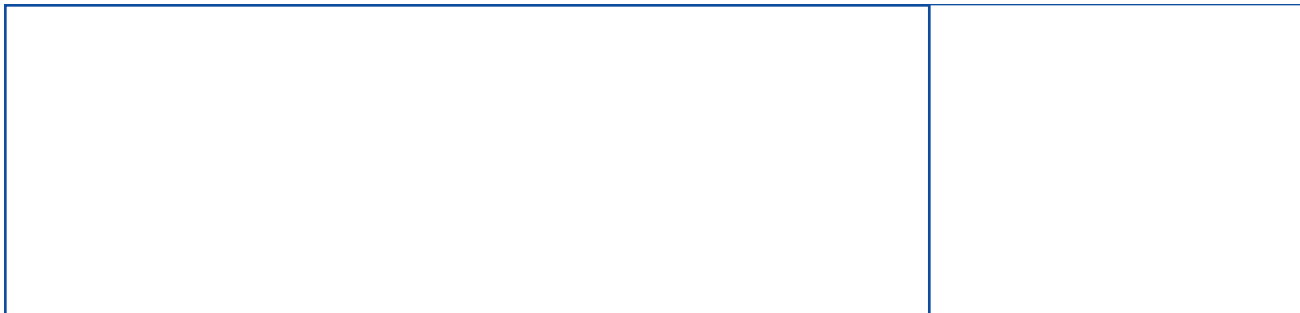
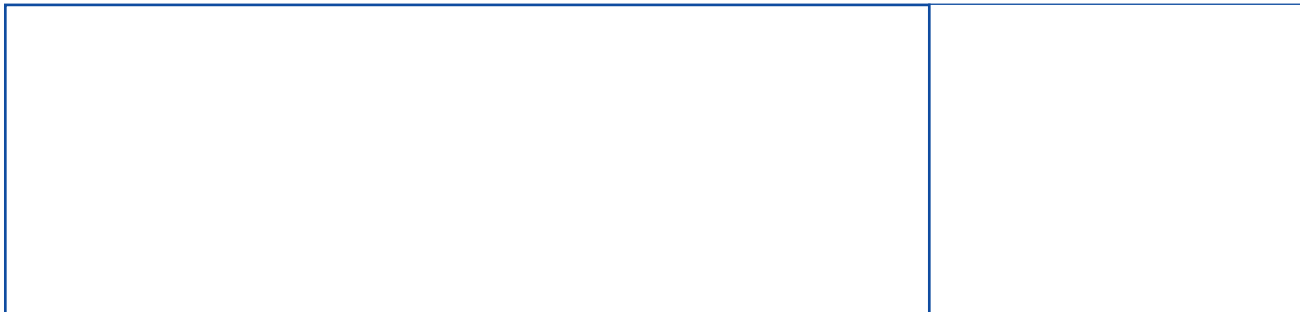

Suffix Key; OE = Original Equipment, R = Reconditioned Part
OEM = Original Equipment Manufacturer, ALT = Alternative Supplier Part

OE Numbers used for Cross Reference Purposes Only

sales@direct-sourcing-solutions.com www.direct-sourcing-solutions.com

Tel; +44 (0) 1653 668179 Fax; +44 (0) 1905 507755

Section: 16, Pg: 3



Lighting: Headlamps & Associated Parts

609025

7701044518

Headlamp L/H

MASTER 1999



609024

7701044520

Headlamp R/H

MASTER 1999



680025OEM

5010544119

Headlamp L/H

MIDLUM



680026OEM

5010544120

Headlamp R/H

MIDLUM



609035

5001840476

Headlamp L/H

PREMIUM /TR/PR



Suffix Key; OE = Original Equipment, R = Reconditioned Part

OEM = Original Equipment Manufacturer, ALT = Alternative Supplier Part

OE Numbers used for Cross Reference Purposes Only

sales@direct-sourcing-solutions.com www.direct-sourcing-solutions.com

Tel; +44 (0) 1653 668179 Fax; +44 (0) 1905 507755

Section: 16, Pg: 4



Lighting: Headlamps & Associated Parts

<p>609036 5001840475 Headlamp R/H PREMIUM /TR/PR</p>	
<p>680004OEM Alternatives; 680004 5010578448 Headlamp L/H Without Fog Lamp PREMIUM PR/TR, PREMIUM DXi 7</p>	
<p>680005OEM Alternatives; 680005 5010578472 Headlamp R/H Without Fog Lamp PREMIUM PR/TR, PREMIUM DXi 7</p>	
<p>680006OEM Alternatives; 680006 5010578460 Headlamp L/H With Fog Lamp Manual Adjustment PREMIUM II</p>	
<p>680007OEM Alternatives; 680007 5010578484 Headlamp R/H With Fog Lamp Manual Adjustment PREMIUM II</p>	

Suffix Key; OE = Original Equipment, R = Reconditioned Part
OEM = Original Equipment Manufacturer, ALT = Alternative Supplier Part

OE Numbers used for Cross Reference Purposes Only

sales@direct-sourcing-solutions.com www.direct-sourcing-solutions.com

Tel; +44 (0) 1653 668179 Fax; +44 (0) 1905 507755

Section: 16, Pg: 5



Lighting: Headlamps & Associated Parts

<p>609033 5010578451 Headlamp L/H With Fog Lamp PREMIUM II</p>	
<p>609032 5010578475 Headlamp R/H With Fog Lamp PREMIUM II</p>	
<p>680009OEM 5010623628 Headlamp L/H MAGNUM</p>	
<p>680010OEM 5010623627 Headlamp R/H MAGNUM</p>	
<p>609031 5010623620 Headlamp L/H MAGNUM E-TECH, MAGNUM DXi 12/13</p>	

Suffix Key; OE = Original Equipment, R = Reconditioned Part
OEM = Original Equipment Manufacturer, ALT = Alternative Supplier Part

OE Numbers used for Cross Reference Purposes Only

sales@direct-sourcing-solutions.com www.direct-sourcing-solutions.com

Tel; +44 (0) 1653 668179 Fax; +44 (0) 1905 507755

Section: 16, Pg: 6



Lighting: Headlamps & Associated Parts

<p>609030 5010623619 Headlamp R/H MAGNUM E-TECH, MAGNUM DXi 12/13</p>	



Lighting: Front Indicator Lamps

<p>609027 7701044522 Corner Lamp L/H MASTER 1999</p>	
<p>609026 7701044523 Corner Lamp R/H MASTER 1999</p>	
<p>609029 7700353946 Corner Lamp L/H MASTER 1999</p>	
<p>609028 7700353947 Corner Lamp R/H MASTER 1999</p>	
<p>609037 5001834560 Corner Lamp L/H MIDLUM /DXi 5/7, PREMIUM /TR/PR, KERAX /DXi 11/13</p>	

Suffix Key; OE = Original Equipment, R = Reconditioned Part
OEM = Original Equipment Manufacturer, ALT = Alternative Supplier Part

OE Numbers used for Cross Reference Purposes Only

sales@direct-sourcing-solutions.com www.direct-sourcing-solutions.com

Tel; +44 (0) 1653 668179 Fax; +44 (0) 1905 507755

Section: 16, Pg: 8



Lighting: Front Indicator Lamps

<p>609038 5001834559 Corner Lamp R/H MIDLUM /DXi 5/7, PREMIUM /TR/PR, KERAX /DXi 11/13</p>	
<p>609034 5001834565 Indicator Lamp L/H & R/H MIDLUM, PREMIUM /TR/PR, KERAX</p>	

Suffix Key; OE = Original Equipment, R = Reconditioned Part
OEM = Original Equipment Manufacturer, ALT = Alternative Supplier Part

OE Numbers used for Cross Reference Purposes Only

sales@direct-sourcing-solutions.com www.direct-sourcing-solutions.com

Tel; +44 (0) 1653 668179 Fax; +44 (0) 1905 507755

Section: 16, Pg: 9



Lighting: Fog Lamps

<p>609039 5010231849 Fog Lamp L/H PREMIUM /TR/PR, KERAX</p>	
---	---

<p>609040 5010231850 Fog Lamp R/H PREMIUM /TR/PR, KERAX</p>	
---	---

--	--

--	--

--	--



Lighting: Rear Lamps & Associated Parts

<p>680019 5001846847 Rear Lamp L/H MIDLUM</p>	
<p>680020 5001846848 Rear Lamp R/H MIDLUM</p>	
<p>680017 5001846843 Tail Lamp L/H M/S, MIDLUM /DXi 5/7</p>	
<p>680018 5001846844 Tail Lamp R/H M/S, MIDLUM /DXi 5/7</p>	
<p>680011 7420802348 Rear Lamp L/H PREMIUM II TR/PR/ DXi 7, KERAX DXi 11/13, MAGNUM DXi 12/13</p>	

Suffix Key; OE = Original Equipment, R = Reconditioned Part
OEM = Original Equipment Manufacturer, ALT = Alternative Supplier Part

OE Numbers used for Cross Reference Purposes Only

sales@direct-sourcing-solutions.com www.direct-sourcing-solutions.com

Tel; +44 (0) 1653 668179 Fax; +44 (0) 1905 507755

Section: 16, Pg: 11



Lighting: Rear Lamps & Associated Parts

<p>680012 7420802350 Rear Lamp R/H PREMIUM II TR/PR/ DXi 7, KERAX DXi 11/13, MAGNUM DXi 12/13</p>	
---	---

<p>680013 7420802353 Rear Lamp R/H Complete With Reverse Alarm PREMIUM II TR/PR/ DXi 7, KERAX DXi 11/13, MAGNUM DXi 12/13</p>	
---	---

<p>680014 7420802418 Rear Lamp Lens L/H & R/H PREMIUM II TR/PR/ DXi 7, KERAX DXi 11/13, MAGNUM DXi 12/13</p>	
--	---

--	--

--	--



Lighting: Side Marker Lamps

<p>690019 5010306792 Marker Lamp MIDLUM /DXi 5/7, PREMIUM /TR/PR, PREMIUM II TR/PR/ DXi 7, KERAX /DXi 11/13, AE MAGNUM, MAGNUM E-TECH, MAGNUM DXi 12/13</p>	



Washer & Wiper Equipment: Washer Pumps

680002

5010276022

Washer Pump

MIDLUM /DXi 5/7, PREMIUM /TR/PR, KERAX, AE MAGNUM, MAGNUM E-TECH



680001

5010578990 7421018113

Washer Pump

PREMIUM



Direct Sourcing Solutions

Renault Catalogue 6.14.1



This Page Is Intentionally Left Blank

Suffix Key; OE = Original Equipment, R = Reconditioned Part
OEM = Original Equipment Manufacturer, ALT = Alternative Supplier Part

OE Numbers used for Cross Reference Purposes Only

sales@direct-sourcing-solutions.com www.direct-sourcing-solutions.com

Tel; +44 (0) 1653 668179 Fax; +44 (0) 1905 507755

Direct Sourcing Solutions Ltd trading as DSS - Terms and Conditions of Sale

GENERAL

These conditions prevail over any conditions which the purchaser's order may purport to impose and which are at variance with the same. No modifications shall be binding upon Direct Sourcing Solutions Limited unless specifically accepted in writing. Direct Sourcing Solutions Ltd will be referred to as DSS hereafter. Typing and clerical errors are subject to correction. All orders or contracts are subject to acceptance by DSS at its office at Kirby Misperton, Malton, regardless if taken elsewhere by a sales person or a selling agent. Quotations do not constitute an offer and shall not bind DSS, until an order has been placed and accepted.

PAYMENT

Unless other terms are expressly agreed upon, payment is Nett 30 days monthly account. DSS reserves the right to impose on the buyer the special term "Cash on Delivery", if it considers it necessary. Payment should be made to Direct Sourcing Solutions Ltd. In addition to its other remedies DSS, reserves the right to change interest on delayed payment from the due date on a daily basis at Fortis Bank plc base rate from time to time in force plus three percent.

PROPERTY

Notwithstanding delivery and the passing of risk in the goods, the property in the goods shall not pass to the buyer until DSS has received in cash or cleared funds payment in full of the price of the goods sold or agreed to be sold by DSS to the buyer under the contract.

Until the property in the goods passes to the buyer:

- a) the buyer shall hold the goods as DSS bailee, and shall keep those goods separate from all other goods and property stored, protected and insured and identified as DSS's property and
- b) the buyer shall be entitled to resell or use the goods in the ordinary course of its business, but shall have a fiduciary duty to DSS to account for the proceeds of sale or otherwise of the goods, whether tangible or intangible, including insurance proceeds, and shall keep all such proceeds separate from any monies or property of the buyer and third parties and , in the case of tangible proceeds, property stored, protected and insured; and
- c) DSS shall be entitled at any time to require the buyer to deliver up the goods to DSS and, if the buyer fails to do so forthwith, to enter upon any premises of the buyer or any third party where the goods are stored and repossess the goods and for that purpose the buyer hereby authorises and licences DSS to enter upon any land or building upon which the goods are situated to recover those goods.

The buyer shall not be entitled to or in any way charge by way of security for any indebtedness any of the goods which remain the property of DSS, but if the buyer does so all monies owing by the buyer to DSS shall, without prejudice to any other right or remedy of DSS, forthwith become due and payable.

INSPECTION AND RETURN OF GOODS

If upon receipt of goods from DSS the goods do not appear to conform to specifications, the buyer must notify DSS within 5 working days after receipt in writing. The return of correctly supplied goods when accepted by DSS will incur a charge of 20% of the value of the goods excluding VAT at current rate. Goods supplied as special orders are not returnable. Goods cannot be returned without prior authorisation from DSS.

EXCHANGE ITEMS

A surcharge is levied on the exchange items (e.g. items that can be reconditioned). The surcharge is refundable subject to the following conditions:

- a) The exchange items are returned within 10 days.
- b) The exchange items are not broken, damaged or dismantled.

TELEPHONED ORDERS

Verbal or telephoned orders, or any variation, must be confirmed in writing by the Buyer otherwise DSS accept no responsibility for errors or subsequent misunderstandings. DSS assumes no responsibility for any orders which are duplicated, as a result of a confirming order not being identified as such.

ORDER CLASSIFICATION

VOR emergencies must be negotiated at the time of the order being placed. If the order product is available, it will be dispatched the same day, providing the order is received early enough to allow dispatch. We request VOR orders to be placed before 4.00pm

CATALOGUE, PRICE LIST AND OTHER ADVERTISEMENT MATTERS

Catalogues, price lists and other material used for advertising are only an indication of the type of goods, and no other particulars contained therein shall be binding to DSS.

VAT

Unless otherwise stated, all prices quoted by DSS do not include value added tax at the current rate.

PRICES

DSS reserves the right to vary the quoted price and goods will be invoiced at the price ruling at the day of dispatch unless otherwise agreed by DSS in writing.

DELIVERY DATES

Whilst DSS will do its utmost to keep its promised delivery dates, they are to be treated as estimates only. DSS accept no responsibility for loss or damage resulting from delay in the delivery of goods. Delays due to circumstances outside the control of DSS shall not entitle the buyer to cancel any order or to refuse to accept delivery.

WARRANTY CLAIM

In the event of a warranty claim DSS must be promptly notified in writing on the appropriate DSS form, and will only accept claims due to faulty materials or workmanship. Goods must be returned carriage paid for immediately upon the discovery of the defect. No credit will be given until such time as DSS is satisfied that such defects arose solely through mentioned causes and DSS has received credit from the manufacturer or supplier. DSS shall in no circumstances be liable for any consequential loss or damages. All replacement items for warranty claims will be booked out at the current DSS price.

DELIVERY CLAIMS

Damage in transit or shortage must be reported within 7 days of receipt of goods or, in the case of an undelivered consignment, within 7 days of the invoice date.

Direct Sourcing Solutions

Renault Catalogue 6.14.1



This Page Is Intentionally Left Blank

Suffix Key; OE = Original Equipment, R = Reconditioned Part
OEM = Original Equipment Manufacturer, ALT = Alternative Supplier Part

OE Numbers used for Cross Reference Purposes Only

sales@direct-sourcing-solutions.com www.direct-sourcing-solutions.com

Tel; +44 (0) 1653 668179 Fax; +44 (0) 1905 507755



DIRECT SOURCING SOLUTIONS LTD
Unit 8A
Beansheaf Industrial Park
Tofts Road
Kirby Misperton
Malton
N.Yorkshire
YO17 6BG

Tel: +44 (0)1653 668179
Fax: +44 (0)1905 507755
www.direct-sourcing-solutions.com
email: sales@direct-sourcing-solutions.com